



M2 Series

Modular Indoor Air Handling Units
& Self-Contained Units



UL-1995



Installation, Operation & Maintenance

⚠ WARNING

FIRE OR EXPLOSION HAZARD

Failure to follow safety warnings exactly could result in serious injury, death or property damage.

Be sure to read and understand the installation, operation and service instructions in this manual.

Improper installation, adjustment, alteration, service or maintenance can cause serious injury, death or property damage.

A copy of this IOM should be kept with the unit.

⚠ WARNING

Do not store gasoline or other flammable vapors and liquids in the vicinity of this or any other appliance.

WHAT TO DO IF YOU SMELL GAS

- Do not try to light any appliance.
- Do not touch any electrical switch; do not use any phone in your building.
- Leave the building immediately.
- Immediately call you gas supplier from a phone remote from the building. Follow the gas supplier's instructions.
- If you cannot reach your gas supplier call the fire department.

Startup and service must be performed by a Factory Trained Service Technician.

Table of Contents

Safety	8
Feature String Nomenclature	15
M2 Series Base Feature String Nomenclature	16
Fan Module Description	17
Filter Module Description	18
Mixing Module Description	19
Heat Module Description	20
Blank Module Description	22
Coil Module Description	23
Controls Module Description	25
Energy Recovery Module Description	26
Water-Source Heat Pump Module Description	27
Unit Orientation	28
General Information	29
Codes and Ordinances	30
Receiving Unit	30
Storage	31
Direct Expansion (DX) Units	31
Gas or Electric Heating	32
Wiring Diagrams	32
Condensate Drain Pan	32
Installation	34
Locating Units	34
Lifting the Assembled Unit	35
Lifting the Individual Modules	38
Floor Mounted Units	38
Module Assembly	39
Evaporator Coils	43
Hot Gas Reheat	43
Hot Gas Bypass	43
Refrigerant-to-Water Heat Exchanger	44
Open Loop Applications	44
Freezing Water in the Heat Exchanger	45
Water Piping	45
Heat Exchanger Safeties	48
Waterside Economizer	48
Heating Coils	49
Chilled Water Coils	50
Condensate Drain Piping	50
Blower Wheels	52
Electrically Commutated Motor (ECM) Air Adjustment	52
Banded Wheel Air Adjustment	53
Electric Heating	55
Electrical	55
Cutting Electrical Openings	56

Fuses and Circuit Breakers	57
Thermostat Control Wiring.....	57
Gas Fired Furnace	58
Unit Location and Clearances.....	58
Gas Supply, Piping and Connections.....	59
Gas Furnace Component Identification	61
General Venting.....	62
Vertically Vented.....	62
Horizontally Vented.....	63
Two-Pipe Separated Combustion Venting	63
Energy Recovery Units	67
Initial Mechanical Check and Setup	67
Routine Maintenance and Handling	68
Cleaning.....	69
Wheel Drive Components.....	70
Startup Procedure.....	70
Service	71
Startup.....	73
Filters.....	74
Check Out.....	74
Gas Heater	75
Operating and Safety Instructions	75
Gas Heater Start-up.....	75
Gas Heater Shut Down	78
Commissioning.....	81
Operation.....	81
Adjusting Refrigerant Charge	81
Refrigeration Troubleshooting	87
Maintenance.....	88
Fan Assembly	88
Bearings.....	88
Belts.....	89
Indoor Coils.....	90
Refrigeration Cycle	90
Braze Plate Heat Exchanger Cleaning	90
E-Coated Coil Cleaning	90
Gas Furnace.....	92
Electric Heating.....	93
Steam or Hot Water Heating	93
Cleaning	93
Chilled Water	93
DX Water Source Cooling	93
Condensate Drain Pans.....	93
Lubrication	93
Phase and Brownout Protection Module.....	95
Replacement Parts	95

AAON Technical Support.....	95
Filter Replacement	99
Decommissioning.....	99
Appendix A - Heat Exchanger Corrosion Resistance.....	102
Split System Piping Diagrams	104
M2 Series Startup Form	122
Maintenance Log	128
Literature Change History.....	131

Index of Tables and Figures

Tables:

Table 1 – Electric and Gas Heating Capacities.....	33
Table 2 - Minimum Clearances.....	35
Table 3 - Glycol Freezing Points	45
Table 4 - Standard Water-Source Connections.....	46
Table 5 – Steam Distributing Coil Sweat Connection Sizes (OD)	49
Table 6 – Hot Water Coil Sweat Connection Sizes (OD).....	49
Table 7 – Chilled Water Coil Sweat Connection Sizes (OD).....	50
Table 8 – Draw-Through and Blow-Through Drain Trap Dimensions (Metric).....	51
Table 9 – Draw-Through and Blow-Through Drain Trap Dimensions (Imperial).....	51
Table 10 - Nameplate Voltage Markings.....	55
Table 11 – 35 KAIC Fuse Sizing.....	57
Table 12 – 65 KAIC Fuse Sizing.....	57
Table 13 - Control Wiring.....	58
Table 14 – Gas Inlet Pressure (Metric).....	59
Table 15 – Gas Inlet Pressures (Imperial).....	59
Table 16 – Vent Pipe Connection Size	62
Table 17 - Gas Heater Troubleshooting.....	80
Table 18 - Acceptable Refrigeration Circuit Values (Metric)	82
Table 19 - Acceptable Refrigeration Circuit Values (Imperial)	82
Table 20 - Acceptable Water-Cooled Refrigeration Circuit Values (Metric).....	83
Table 21 - Acceptable Water-Cooled Refrigeration Circuit Values (Imperial).....	83
Table 22 - R-410A Refrigerant Temperature-Pressure Chart (Metric)	85
Table 23 - R-410A Refrigerant Temperature-Pressure Chart (Imperial).....	86
Table 24 – Refrigeration Problems, Causes, and Solutions.....	87
Table 25 - Bearing Setscrew Torque Recommendations (Metric)	89
Table 26 - Bearing Setscrew Torque Recommendations (Imperial)	89
Table 27 - Min and Max Water Pressures and Temps.....	93
Table 28 - Fan Bearing Lubrication Schedule	94
Table 29 - M2-018	100
Table 30 - M2-026 Filters.....	100
Table 31 - M2-036 Filters.....	100

Figures:

Figure 1 - Typical M2 Series Selection	15
Figure 2 - Unit Orientation	28
Figure 3 - Lockable Handle	31
Figure 4 - Service Access Clearance	35
Figure 5 - M2 Series Unit Four Point Lifting.....	36
Figure 6 - M2 Series Unit Eight Point Lifting	37
Figure 7 - M2 Series Individual Module Bottom Tier Lifting.....	38
Figure 8 - M2 Series Individual Module Top Tier Lifting	38
Figure 9 - Module Assembly Schematic.....	40
Figure 10 - Bolted Base Rail.....	41
Figure 11 - Bar Clamp	41
Figure 12 - Self-Tapping Screw.....	41
Figure 13 - Strap Types.....	42
Figure 14 - Strap Locations.....	42
Figure 15 - Strap Positioning	42
Figure 16 - Strap Installation	42
Figure 17 - Power and Control Wiring	42
Figure 18 - Quick Connects	42
Figure 19 - TXV Bulb Position.....	43
Figure 20 - Water-Source Heat Pump Water Piping	46
Figure 21 - Water-Cooled Only Water Piping.....	46
Figure 22 – Waterside Economizer Piping.....	48
Figure 23 - Steam Distributing Piping.....	49
Figure 24 - Hot Water Piping.....	50
Figure 25 - Chill Water Piping.....	50
Figure 26 - Draw-Through Drain Trap	51
Figure 27 - Blow-Through Drain Trap	52
Figure 28 – Jumper for Remote Fan Speed Control	52
Figure 29 – Potentiometer.....	53
Figure 30 - Supply Fan Banding.....	54
Figure 32 - Sediment Trap for Gas Heat.....	60
Figure 33 – Gas Heater Component Identification.....	61
Figure 33 – Indoor Vertical Venting (Category I).....	65
Figure 34 – Indoor Horizontal Venting (Category III)	65
Figure 35 – Indoor Vertical Venting Separated Combustion	66
Figure 36 – Indoor Horizontal Venting Separated Combustion	66
Figure 37 - Energy Recovery Wheel	67
Figure 38 - Cross Section of Air Seal Structure	67
Figure 39 - Lifting Hole Locations	68
Figure 40 - Avoid Racking of Cassette Frame.....	70
Figure 41 - Diameter Seal Adjustment	71
Figure 42 - Hub Seal Adjustment	71
Figure 43 - Segment Retainer	72
Figure 44 - Segment Installation.....	72

Figure 45 - Belt Replacement	73
Figure 46 – Combination Gas Valve	76
Figure 47 – 2.2mmHg (1.2” w.c.) Manifold Natural Gas.....	77
Figure 48 -6.5 mmHg (3.5” w.c.) Manifold Natural Gas	77
Figure 49 - Flame Sensor Current Check	78
Figure 51 - Angular Misalignment	89
Figure 52 - Parallel Misalignment	89
Figure 53 - Belt Deflection	90
Figure 53 - Filter Layout.....	101
Figure 54 - A/C Split System Piping, Suction Down	104
Figure 55 - A/C Split System Piping, Suction Up	105
Figure 56 - A/C with LAC Split System Piping, Suction Down	106
Figure 57 - A/C with LAC Split System Piping, Suction Up	107
Figure 58 - A/C with Modulating Hot Gas Reheat Split System Piping, Suction Down	108
Figure 59 - A/C with Modulating Hot Gas Reheat Split System Piping, Suction Up	109
Figure 60 - A/C with Hot Gas Bypass Split System Piping, Suction Down	110
Figure 61 - A/C with Hot Gas Bypass Split System Piping, Suction Up	111
Figure 62 - A/C with Modulating Hot Gas Reheat and Hot Gas Bypass Split System Piping, Suction Down.....	112
Figure 63 - A/C with Modulating Hot Gas Reheat and Hot Gas Bypass Split System Piping, Suction Up	113
Figure 64 - Heat Pump Split System Piping, Suction Down	114
Figure 65 - Heat Pump Split System Piping, Suction Up	115
Figure 66 - Heat Pump with Modulating Hot Gas Reheat Split System Piping, Suction Down	116
Figure 67 - Heat Pump with Modulating Hot Gas Reheat Split System Piping, Suction Up.....	117
Figure 68 - Heat Pump with Hot Gas Bypass Split System Piping, Suction Down	118
Figure 69 - Heat Pump with Hot Gas Bypass Split System Piping, Suction Up	119
Figure 70 - Heat Pump with Modulating Hot Gas Reheat and Hot Gas Bypass Split System Piping, Suction Down.....	120
Figure 71 - Heat Pump with Modulating Hot Gas Reheat and Hot Gas Bypass Split System Piping, Suction Up.....	121

G149590 · Rev. A · 240828
(ACP J000304)

Safety

Attention should be paid to the following statements:

NOTE - Notes are intended to clarify the unit installation, operation and maintenance.

⚠ CAUTION - Caution statements are given to prevent actions that may result in equipment damage, property damage, or personal injury.

⚠ WARNING - Warning statements are given to prevent actions that could result in equipment damage, property damage, personal injury or death.

⚠ DANGER - Danger statements are given to prevent actions that will result in equipment damage, property damage, severe personal injury or death.

⚠ WARNING

ELECTRIC SHOCK, FIRE OR EXPLOSION HAZARD

Failure to follow safety warnings exactly could result in dangerous operation, serious injury, death or property damage.

Improper servicing could result in dangerous operation, serious injury, death, or property damage.

- Before servicing, disconnect all electrical power to the furnace. More than one disconnect may be provided.
- When servicing controls, label all wires prior to disconnecting. Reconnect wires correctly.
- Verify proper operation after servicing. Secure all doors with key-lock or nut and bolt.

⚠ WARNING

QUALIFIED INSTALLER

Improper installation, adjustment, alteration, service or maintenance can cause property damage, personal injury or loss of life. Startup and service must be performed by a Factory Trained Service Technician. A copy of this IOM should be kept with the unit.

⚠ CAUTION

WHAT TO DO IF YOU SMELL GAS

- Do not try to turn on unit.
- Shut off main gas supply.
- Do not touch any electric switch.
- Do not use any phone in the building.
- Leave the building immediately.
- Immediately call your gas supplier from a neighbor's phone. Follow the gas supplier's instructions.
- If you cannot reach your gas supplier, call the fire department.

! WARNING

Electric shock hazard. Before servicing, shut off all electrical power to the unit, including remote disconnects, to avoid shock hazard or injury from rotating parts. Follow proper Lockout-Tagout procedures.

! WARNING

CARBON-MONOXIDE POISONING HAZARD

Failure to follow instructions could result in severe personal injury or death due to carbon-monoxide poisoning, if combustion products infiltrate into the building.

Check that all openings in the outside wall around the vent (and air intake) pipe(s) are sealed to prevent infiltration of combustion products into the building.

Check that furnace vent (and air intake) terminal(s) are not obstructed in any way during all seasons.

! WARNING

FIRE, EXPLOSION OR CARBON MONOXIDE POISONING HAZARD

Failure to replace proper controls could result in fire, explosion or carbon monoxide poisoning. Failure to follow safety warnings exactly could result in serious injury, death or property damage. Do not store or use gasoline or other flammable vapors and liquids in the vicinity of this appliance.

! WARNING

During installation, testing, servicing, and troubleshooting of the equipment it may be necessary to work with live electrical components. Only a qualified licensed electrician or individual properly trained in handling live electrical components shall perform these tasks.

Standard NFPA-70E, an OSHA regulation requiring an Arc Flash Boundary to be field established and marked for identification of where appropriate Personal Protective Equipment (PPE) be worn, should be followed.

! WARNING

ROTATING COMPONENTS

Unit contains fans with moving parts that can cause serious injury. Do not open door containing fans until the power to the unit has been disconnected and fan wheel has stopped rotating.

! WARNING

GROUNDING REQUIRED

All field installed wiring must be completed by qualified personnel. Field installed wiring must comply with NEC/CEC, local and state electrical code requirements. Failure to follow code requirements could result in serious injury or death. Provide proper unit ground in accordance with these code requirements.

! WARNING

VARIABLE FREQUENCY DRIVES

Do not leave VFDs unattended in hand mode or manual bypass. Damage to personnel or equipment can occur if left unattended. When in hand mode or manual bypass mode VFDs will not respond to controls or alarms.

! CAUTION

Electric motor over-current protection and overload protection may be a function of the Variable Frequency Drive to which the motors are wired. Never defeat the VFD motor overload feature. The overload ampere setting must not exceed 115% of the electric motors FLA rating as shown on the motor nameplate.

! WARNING

UNIT HANDLING

To prevent injury or death lifting equipment capacity shall exceed unit weight by an adequate safety factor. Always test-lift unit not more than 61 cm (24 inches) high to verify proper center of gravity lift point to avoid unit damage, injury or death.

! CAUTION

Rotation must be checked on all **MOTORS AND COMPRESSORS** of 3 phase units at startup by a qualified service technician. Scroll compressors are directional and can be damaged if rotated in the wrong direction. Compressor rotation must be checked using suction and discharge gauges. Fan motor rotation should be checked for proper operation. Alterations should only be made at the unit power connection

! CAUTION

Failure to properly drain and vent coils when not in use during freezing temperature may result in coil and equipment damage.

! WARNING

Do not use oxygen, acetylene or air in place of refrigerant and dry nitrogen for leak testing. A violent explosion may result causing injury or death.

! WARNING

This appliance is not intended for use by persons with reduced physical, sensory or mental capabilities, or lack of experience and knowledge, unless they have been given supervision or instruction concerning use of the appliance by a person responsible for their safety. Children must be supervised around this appliance.

! WARNING

WATER PRESSURE

Prior to connection of condensing water supply, verify water pressure is less than maximum pressure shown on unit nameplate. To prevent injury or death due to instantaneous release of high pressure water, relief valves should be field supplied on system water piping.

! WARNING

Always use a pressure regulator, valves and gauges to control incoming pressures when pressure testing a system. Excessive pressure may cause line ruptures, equipment damage or an explosion which may result in injury or death.

! CAUTION

To prevent damage to the unit, do not use acidic chemical coil cleaners. Do not use alkaline chemical coil cleaners with a pH value greater than 8.5, after mixing, without first using an aluminum corrosion inhibitor in the cleaning solution.

! WARNING

Some chemical coil cleaning compounds are caustic or toxic. Use these substances only in accordance with the manufacturer's usage instructions. Failure to follow instructions may result in equipment damage, injury or death.

! CAUTION

Door compartments containing hazardous voltage or rotating parts are equipped with door latches to allow locks. Door latches are shipped with nut and bolts requiring tooled access. If you do not replace the shipping hardware with a pad lock always re-install the nut & bolt after closing the door.

! CAUTION

Do not clean DX refrigerant coils with hot water or steam. The use of hot water or steam on refrigerant coils will cause high pressure inside the coil tubing and damage to the coil.

! CAUTION

Cleaning the cooling tower or the condenser water loop with harsh chemicals, such as hydrochloric acid (muriatic acid) or chlorine, can damage the water-cooled condenser. Care should be taken to avoid allowing chemicals to enter the water-cooled condenser. See Appendix A - Heat Exchanger Corrosion Resistance for more information.

! CAUTION

In order to avoid a hazard due to inadvertent resetting of the THERMAL CUT-OUT, this appliance must not be supplied through an external switching device, such as a timer, or connected to a circuit that is regularly switched on and off by the utility.

! WARNING

OPEN LOOP APPLICATIONS

Failure of the condenser as a result of chemical corrosion is excluded from coverage under AAON Inc. warranties and the heat exchanger manufacturer's warranties.

! WARNING

WATER FREEZING

Failure of the condenser due to freezing will allow water to enter the refrigerant circuit and will cause extensive damage to the refrigerant circuit components. Any damage to the equipment as a result of water freezing in the condenser is excluded from coverage under AAON warranties and the heat exchanger manufacturer warranties.

! WARNING

HOT PARTS

Disconnect all power, close all isolation valves and allow equipment to cool before servicing equipment to prevent serious injury. Equipment may have multiple power supplies. Electric resistance heating elements and hot water or steam heating coils may have automatic starts. Hot water will circulate even after power is off.

! CAUTION

PVC (Polyvinyl Chloride) and CPVC (Chlorinated Polyvinyl Chloride) are vulnerable to attack by certain chemicals. Polyolester (POE) oils used with R-410A and other refrigerants, even in trace amounts, in a PVC or CPVC piping system will result in stress cracking of the piping and fittings and complete piping system failure.

! WARNING

Do not weld or cut foam panel with plasma cutters or a cutting torch – When burnt the foam produces dangerous fumes.

! WARNING

Do not work in a closed area where refrigerant or nitrogen gases may be leaking. A sufficient quantity of vapors may be present and cause injury or death.

! WARNING

Never attempt to open an access door or remove a panel while the unit is running. Pressure in the unit can cause excessive force against the panel.

 **WARNING**

Ensure that sufficient dampers will be open to provide air path before fan is allowed to run.

 **CAUTION**

COMPRESSOR CYCLING

5 MINUTE OFF TIME

To prevent motor overheating, compressors must cycle off for a minimum of 5 minutes.

5 MINUTE ON TIME

To maintain the proper oil level, compressors must cycle on for a minimum of 5 minutes.

The cycle rate must not exceed 6 starts per hour.

 **WARNING**

Units with VFD driven motors/compressors have adjustable overload settings. These are set by the AAON factory for the protection of these motors/compressors and must not be adjusted over this factory setpoint or bypassed.

1. Startup and service must be performed by a Factory Trained Service Technician.
2. The unit is for indoor use only. See General Information section for more unit information.
3. Use only with type of the gas approved for the furnace. Refer to the furnace rating plate.
4. Install this furnace only in a location and position as specified in the Installation section of this manual. The gas heat module must be installed on the positive pressure side of the supply fan.
5. Provide adequate combustion ventilation air to the furnace. If a vent duct extension is used, a class III approved vent is required. See the Locating Units and Gas Heating sections of the Installation section of the manual.
6. Combustion products must be discharged to the outdoors. Connect the furnace to an approved vent system. See the **General Venting** section of this manual.
7. Never test for gas leaks with an open flame. Use a commercially available soap solution made specifically for the detection of leaks to check all connections.

8. Always install and operate furnace within the intended temperature rise range and duct system external static pressure (ESP) as specified on the unit nameplate.
9. The supply and return air ducts must be derived from the same space. It is recommended ducts be provided with access panels to allow inspection for duct tightness. When a down flow duct is used with electric heat, the exhaust duct should be an L shaped duct.
10. Clean furnace, duct and components upon completion of the construction setup. Verify furnace operating conditions including input rate, temperature rise and ESP.
11. Every unit has a unique equipment nameplate with electrical, operational, and unit clearance specifications. Always refer to the unit nameplate for specific ratings unique to the model you have purchased.
12. READ THE ENTIRE INSTALLATION, OPERATION AND MAINTENANCE MANUAL. OTHER IMPORTANT SAFETY PRECAUTIONS ARE PROVIDED THROUGHOUT THIS MANUAL.
13. Keep this manual and all literature safeguarded near or on the unit.

Feature String Nomenclature

Base Feature String
Identifies the main unit features and options.

Individual Module Feature String
Identifies module configurations, features and options.

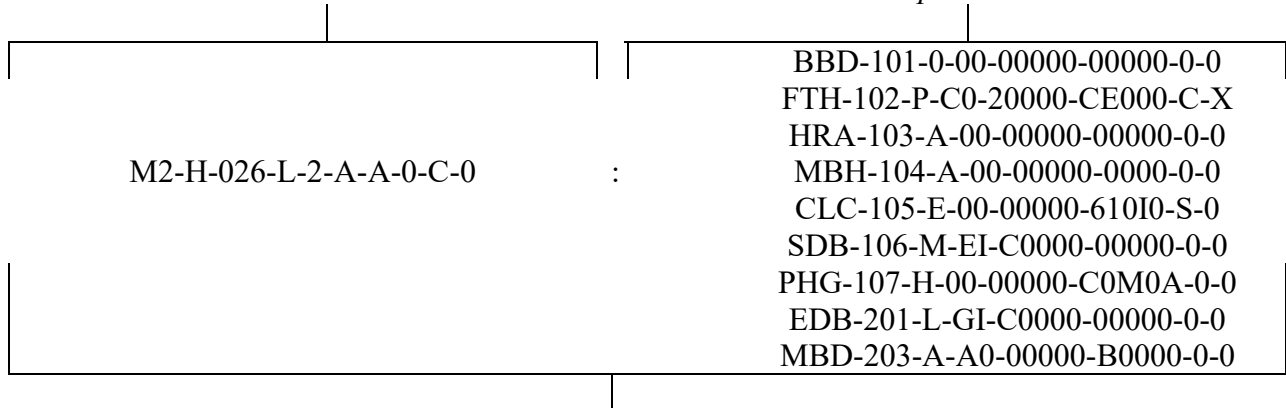

Complete Feature String

A complete unit feature string consists of a base model feature string followed by a series of individual module feature strings. The first three letters of the individual module model number identify the type of module (fan, filter, coil, etc). The three numbers after the three letters indicate the position of the module in unit assembly. If the module is on the bottom level, the first number is 1 while the first number in the top level is 2. The last

number increases in value from the return/outside air section to the discharge air section. In the below example, the cooling coil module in Figure 1, CLC-105-E-00-00000-610I0-0-0, is the fifth module on the first level of the unit. The exhaust fan, EDB-201-L-GI-C000-00000-0-0, is the first module on the second level.

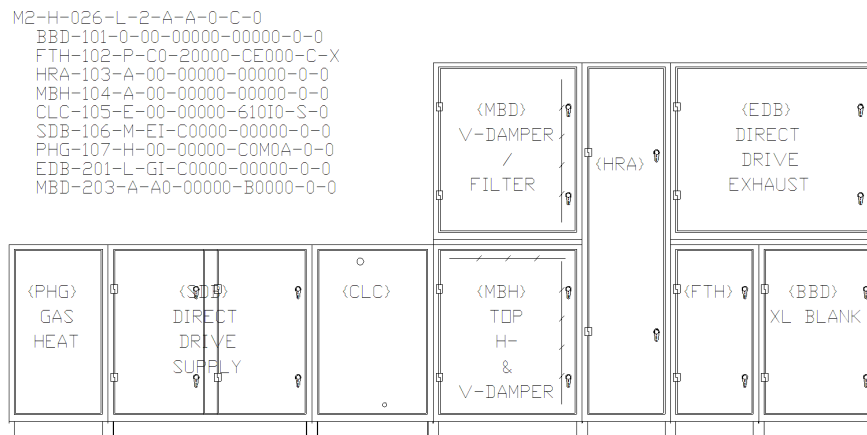

Figure 1 - Typical M2 Series Selection

M2 Series Base Feature String Nomenclature

Model Options

GEN	TYPE	UNIT SIZE	SUPPLY AIRFLOW	VOLTAGE	ASSEMBLY	WIRING	PAINT	BASE RAIL	SPECIAL
M2	H	011	R	2	A	A	0	C	0

BASE MODEL DESCRIPTION

Series and Generation

M2

Type

H = Horizontal

Unit Size

018 = 18 ft² Coil (3800 – 9800)

026 = 26 ft² Coil (5200-14800)

036 = 36 ft² Coil (7000-21000)

Supply Airflow

L = Left Hand

R = Right Hand

Voltage

2 = 230V/3Φ/60Hz

3 = 460V/3Φ/60Hz

4 = 575V/3Φ/60Hz

8 = 208V/3Φ/60Hz

Assembly

A = Factory Assembled

B = Individual Boxes

Wiring

0 = No Factory Wiring

A = Control Wiring in Fan Box

B = Control Wiring in Control Box

Paint

0 = None - Standard

A = Indoor Unit with Exterior Corrosion Protection

B = Indoor Unit with Interior and Exterior Corrosion Protection

E = Shipping Shrink Wrap

F = Indoor Unit with Exterior Corrosion Protection + Shipping Shrink Wrap

G = Indoor Unit with Interior and Exterior Corrosion Protection + Shipping Shrink Wrap

Base Rail

C = 6" High

Special

0 = None

X = Special Pricing Authorization

Fan Module Feature String Nomenclature

MODULE ID	POSITION	MOTOR SIZE	BLOWER	ISOLATION	MOTOR TYPE	BLANK	PULLEYS	SAFETY CONTROL	BLANK	BLANK	SPECIAL
SDD	- 103	- J	- B	I	- F	00	00	- A	0000	- 0	- 0

FAN MODULE DESCRIPTION

Module ID

SFA = Belt Driven Supply
 SFC = Belt Drive Supply, Top Discharge
 SFD = Belt Driven Supply, No Control Panel
 SDB = Direct Drive Supply
 SDD = Direct Drive Supply, Top Discharge
 SDM = Dual Fan Direct Drive Supply
 SDN = Dual Fan Direct Drive Supply, Top Discharge
 PEA = Belt Driven Power Exhaust
 PEC = Belt Driven Power Exhaust, Top Discharge
 EDB = Direct Drive Power Exhaust
 EDD = Direct Drive Power Exhaust, Top Discharge
 RFA = Belt Driven Power Return
 RDB = Direct Drive Power Return
 RDM = Dual Fan Direct Drive Power Return

Position

= Level and Position of Module in Air Handling Unit

Motor Size

E = 1 hp
 F = 2 hp
 G = 3 hp
 H = 5 hp
 J = 7.5 hp
 K = 10 hp
 L = 15 hp
 M = 20 hp
 N = 25 hp
 P = 30 hp
 Q = 1.0 kW (1.3 hp)
 S = 1.7 kW (2.3 hp)
 T = 3.0 kW (4.0 hp)
 U = 5.4 kW (8.0 hp)

Blower

A = 15" Backward Curved Plenum
 B = 18" Backward Curved Plenum
 C = 22" Backward Curved Plenum
 D = 27" Backward Curved Plenum
 E = 30" Backward Curved Plenum
 F = 33" Backward Curved Plenum
 G = 37" Backward Curved Plenum
 H = 24" Backward Curved Plenum

Blower Continued

J = 15" BC Plenum - 50% Width
 K = 18" BC Plenum - 30% Width
 L = 2 x 18" Backward Curved Plenum
 M = 2 x 22" Backward Curved Plenum
 N = 2 x 24" Backward Curved Plenum
 P = 2 x 27" Backward Curved Plenum
 Q = 14" ECM Backward Curved Plenum
 R = 16" ECM Backward Curved Plenum
 S = 18" ECM Backward Curved Plenum
 T = 18" ECM Backward Curved Plenum

Isolation

0 = Standard
 I = Fan Isolation

Motor Type

A = Standard Efficiency 1760 rpm
 B = Premium Efficiency 1760 rpm
 C = Premium Eff. 1760 rpm with VFD
 D = Premium Eff. 1760 rpm with VFD and Bypass
 E = Premium Efficiency 1170 rpm
 F = Premium Eff. 1170 rpm with VFD
 G = EC Motor

Blank

00 = Standard

Pulleys

= Pulley Combination

Safety Control

0 = None
 A = Phase & Brownout Protection

Blank

0000 = Standard

Blank

0 = Standard

Special

0 = None
 X = Special Pricing Authorization

Filter Module Feature String Nomenclature

MODULE ID	POSITION	FILTER TYPE	FILTERS	SAFETY CONTROL	BLANK	2 ND FILTER TYPE	2 ND FILTER	BLANK	FILTER OPTIONS	SPECIAL
FTA	- 102	- P	- A0	- 0	0000	- 0	00	00	- 0	- 0

FILTER MODULE DESCRIPTION

Module ID

FTA = Small Flat Filter
 FTC = Cartridge Filter
 FTE = Medium Flat Filter
 FTF = Large Flat Filter
 FTH = Cartridge Filter with Flat Pre-Filter
 FTK = Extra Large Flat Filter

Position

= Level and Position of Module in Air Handling Unit

Filter Type

P = Pleated
 C = Cartridge

Filters

A0 = 2" Pleated, 30% Eff.
 B0 = 4" Pleated, 30% Eff.
 C0 = 4" Pleated, 65% Eff. or 12" Cartridge, 65% Eff.
 D0 = 4" Pleated, 85% Eff. or 12" Cartridge, 85% Eff.
 E0 = 4" Pleated, 95% Eff. or 12" Cartridge, 95% Eff.

Safety Control

0 = Standard
 2 = Firestat

Blank

0000 = Standard

Second Filter Type

0 = Standard - None
 C = Cartridge

Second Filter

00 = Standard - None
 C0 = 12" Cartridge, 65% Eff.
 D0 = 12" Cartridge, 85% Eff.
 E0 = 12" Cartridge, 95% Eff.

Blank

00 = Standard

Filter Options

0 = Standard - None
 A = Magnehelic Gauge
 B = Clogged Filter Switch
 C = Magnehelic Gauge & Clogged Filter Switch

Special

0 = None
 X = Special Pricing Authorization

Mixing Module Feature String Nomenclature

MODULE ID	POSITION	ACTUATOR TYPE	FILTERS	SAFETY CONTROL	BLANK	BYPASS OPENING	BLANK	FILTER OPTIONS	SPECIAL
MBH	- 101	- A	- 00	- 0	0000	- 0	0000	- 0	- 0

MIXING MODULE DESCRIPTION

Module ID

MBA = Vertical Damper
 MBB = Horizontal Top Damper
 MBC = Vertical & Horizontal Bottom Damper
 MBD = Vertical Damper with Filter
 MBE = Horizontal Top Damper with Filter
 MBF = Horizontal Bottom Damper
 MBH = Vertical & Horizontal Top Damper
 MBI = Horizontal Bottom Damper with Filter
 MBJ = Vertical & Horizontal Top Damper with Filter
 MBK = Vertical & Horizontal Bottom Damper with Filter

Position

= Level and Position of Module in Air Handling Unit

Actuator Type

0 = Standard - None
 A = Two Position Actuator
 B = DDC Actuator

Filters

00 = Standard - None
 A0 = 2" Pleated, 30% Eff.
 B0 = 4" Pleated, 30% Eff.
 C0 = 4" Pleated, 65% Eff.
 D0 = 4" Pleated, 85% Eff.
 E0 = 4" Pleated, 95% Eff.

Safety Control

0 = Standard
 2 = Firestat

Blank

0000 = Standard

Bypass Opening

0 = Standard - None
 A = Top Open
 B = Bottom Open

Blank

0000 = Standard

Filter Options

0 = Standard - None
 A = Magnehelic Gauge
 B = Clogged Filter Switch
 C = Options A + B

Special

0 = Standard - None
 X = Special Pricing Authorization

Heat Module Feature String Nomenclature

MODULE ID	POSITION	FUNCTION	FILTERS	ROWS	FPI	CIRCUITING	COATING	HEAT CAPACITY	STAGES	FUEL GAS	COMB INTAKE	FILTER OPTIONS	SPECIAL
PHA	- 104	- H	- 00	- 0	00	0	0	- E	02	0	0	- 0	- 0

HEAT MODULE DESCRIPTION

Module ID

PHA = Electric Heat
 PHB = Hot Water Coil
 PHC = Hot Water Coil with Filter
 PHD = Electric Heat with Filter
 PHG = Gas Heat

Position

= Level and Position of Module in Air Handling Unit

Function

B = Heating + Dehumidification
 D = Dehumidification
 H = Heating

Filters

00 = None
 A0 = 2" Pleated, 30% Eff.
 B0 = 4" Pleated, 30% Eff.
 C0 = 4" Pleated, 65% Eff.
 D0 = 4" Pleated, 85% Eff.
 E0 = 4" Pleated, 95% Eff.

HEATING COIL

Rows

0 = No Hot Water Heating
 1 = 1 Row
 2 = 2 Rows

FPI

00 = No Hot Water Heating
 08 = 8 Fins Per Inch
 10 = 10 Fins Per Inch
 12 = 12 Fins Per Inch

Circuiting

0 = No Hot Water Heating
 F = Single Serpentine
 H = Half Serpentine
 Q = Quarter Serpentine

Coating

0 = Standard
 H = Stainless Steel Coil Casing & Copper Fins
 P = Polymer E-Coating
 S = Stainless Steel Coil Casing
 K = Stainless Steel Coil Casing & Polymer E-Coating

Heat Capacity

0 = Hot Water Heating Coil
 1 = 50 MBH input
 2 = 75 MBH input
 3 = 100 MBH input
 4 = 125 MBH input
 5 = 150 MBH input
 6 = 175 MBH input
 7 = 200 MBH input
 8 = 250 MBH input
 A = 300 MBH input OR 7 kW (5.3 kW @ 208V)
 B = 350 MBH input OR 14 kW (10.5kW @ 208V)
 C = 400 MBH input OR 21 kW (15.8 kW @ 208V)
 D = 28 kW (21 kW @ 208V)
 E = 42 kW (31.5 kW @ 208V)
 F = 56 kW (42 kW @ 208V)
 G = 70 kW (52.2 kW @ 208V)
 H = 35 kW (26.3 kW @ 208V)
 J = 84 kW (63 kW @ 208V)
 K = 112 kW (84.1 kW @ 208V)
 L = 126 kW (94.6 kW @ 208V)
 M = 168 kW (126.2 kW @ 208V)
 N = 10 kW (7.5 kW @ 208V)
 P = 20 kW (15 kW @ 208V)
 Q = 30 kW (22.5 kW @ 208V)
 R = 40 kW (30 kW @ 208V)
 S = 50 kW (37.5 kW @ 208V)
 T = 80 kW (60.1 kW @ 208V)
 U = 100 kW (75.1 kW @ 208V)
 V = 120 kW (90.1 kW @ 208V)
 W = 160 kW (120.1 kW @ 208V)

Heat Module Feature String Nomenclature

MODULE ID	POSITION	FUNCTION	FILTERS	ROWS	FPI	CIRCUITING	COATING	HEAT CAPACITY	STAGES	FUEL GAS	COMB INTAKE	FILTER OPTIONS	TYPE
PHA	-	104	-	H	-	00	-	0	00	0	0	-	E 02 0 0 - 0 - 0

Stages

00 = Hot Water Heating Coil
 01 = 1 Stage
 02 = 2 Stage
 03 = 3 Stage
 04 = 4 Stage
 0M = Modulating 5:1 Stage Natural Gas
 Modulating 3:1 Stage LP Gas

Fuel Gas

0 = Natural Gas [Hot Water/Electric Heat]
 A = LP Gas

Combustion Intake

0 = Open Combustion [Hot Water/Electric Heat]
 A = Separated Combustion

Filter Options

0 = Standard
 A = Magnehelic Gauge
 B = Clogged Filter Switch
 C = Options A + B

Special

0 = None
 X = Special Pricing Authorization
 S = Steam Heating

Blank Module Feature String Nomenclature

MODULE ID	POSITION	BLANK	AIRWAY TYPE	SAFETY CONTROL	BLANK	BYPASS OPENING	BLANK	DRAIN PAN TYPE	SPECIAL
BBA	- 101	- 0	- AR	- 0	0000	- 0	0000	- 0	- 0

BLANK MODULE DESCRIPTION

Module ID

BBA = Small
 BBC = Large
 BBD = XL
 BBE = XXL

Position

= Level and Position of Module in Air Handling Unit

Blank

0 = Standard

Airway Type

00 = Standard
 AR = Top Open, Right Hand End Panel
 AL = Top Open, Left Hand End Panel

Safety Control

0 = None
 2 = Firestat

Blank

0000 = Standard

Bypass Opening

0 = None
 A = Top Opening
 B = Bottom Opening

Blank

0000 = Standard

Drain Pan Type

0 = None
 A = Auxiliary

Special

0 = None
 X = Special Pricing Authorization

Cooling Coil Module Feature String Nomenclature

MODULE ID	POSITION	COOLING TYPE	ELECTRIC HEAT kW	ELEC HEAT STAGES	HEATING COIL ROWS	HEATING COIL FPI	HEATING COIL CKT	HEAT COIL COATING	COOLING COIL ROWS	COOLING COIL FPI	COOLING COIL CKT	COOL COIL COATING	DRAIN PAN TYPE	SPECIAL
CLC	- 103	- F	- 0	0	- 0	00	0	0	- 6	10	I	P	- S	- 0

COOLING COIL MODULE

DESCRIPTION

Module ID

CLB = Chilled Water or DX
 CLC = DX + Hot Gas Reheat
 CLF = Hot Water + Chilled Water or DX
 CLG = Electric Heat + Chilled Water or DX
 CLI = Hot Water, Chilled Water, or DX with Face and Bypass Dampers
 CLM = Chilled Water or DX, Shorter Length

Position

= Level and Position of Module in Air Handling Unit

Cooling Type

0 = No Cooling
 A = R-410A Hot Gas Bypass [HGB] Lead + HGB Lag
 B = R-410A HGB Non-Variable Compressors [HGBNV]
 C = Chilled Water
 F = DX R-410A
 G = R-410A HGB Lead
 H = R-410A Heat Pump
 J = R-410A HGB Lead + Heat Pump
 K = R-410A HGB Lead + HGB Lag + Heat Pump
 L = R-410A HGBNV + Heat Pump
 M = R-454B DX
 N = R-454B HGB Lead
 P = R-454B Hot Gas Bypass [HGB] Lead + HGB Lag
 Q = R-454B HGB Non-Variable Compressors [HGBNV]
 R = R-454B Heat Pump
 S = R-454B HGB Lead + Heat Pump
 T = R-454B HGB Lead + HGB Lag + Heat Pump
 U = R-454B HGBNV + Heat Pump

ELECTRIC HEAT

Capacity

0 = No Electric Heat
 A = 7 kW (5.3 kW)
 B = 14 kW (10.5 kW)
 C = 21 kW (15.8 kW)
 D = 28 kW (21.0 kW)
 H = 35 kW (26.3 kW)
 E = 42 kW (35.0 kW)
 F = 56 kW (42.0 kW)

ELECTRIC HEAT

Capacity (continued)

G = 70 kW (52.5 kW)
 J = 84 kW (63.1 kW)
 K = 112 kW (84.1 kW)
 L = 126 kW (94.6 kW)
 M = 168 kW (126.2 kW)

Stages

0 = Standard - None
 1 = 1 Stage
 2 = 2 Stage
 3 = 3 Stage
 4 = 4 Stage

HEATING COIL

Rows

0 = No Hot Water Heating
 1 = 1 Row
 2 = 2 Rows

FPI

00 = No Hot Water Heating
 08 = 8 Fins Per Inch
 10 = 10 Fins Per Inch
 12 = 12 Fins Per Inch
 14 = 14 Fins Per Inch

Circuiting

0 = No Hot Water Heating
 F = Single Serpentine
 H = Half Serpentine
 Q = Quarter Serpentine

Coating

0 = Standard
 P = Polymer E-Coating
 S = Stainless Steel Coil Casing
 H = Stainless Steel Coil Casing & Copper Fins
 K = Stainless Steel Coil Casing & Polymer E-Coating

COOLING COIL

Rows

0 = No Cooling Coil
 4 = 4 Rows
 6 = 6 Rows
 8 = 8 Rows

Cooling Coil Module Feature String Nomenclature

MODULE ID	POSITION	COOLING TYPE	ELECTRIC HEAT RW	ELEC HEAT STAGES	HEATING COIL ROWS	HEATING COIL FPI	HEATING COIL CKT	HEAT COIL COATING	COOLING COIL ROWS	COOLING COIL FPI	COOLING COIL CKT	COOL COIL COATING	DRAIN PAN TYPE	SPECIAL
CLC	- 103	- F	- 0	0	- 0	00	0	0	- 6	10	I	P	- S	- 0

FPI

00 = No Cooling Coil
 08 = 8 Fins Per Inch
 10 = 10 Fins Per Inch
 12 = 12 Fins Per Inch

H = Stainless Steel Coil Casing & Copper Fins
 K = Stainless Steel Coil Casing & Polymer E-Coating

Drain Pan

0 = No Drain Pan
 S = Stainless Steel

Circuiting

0 = No Cooling Coil
 D = Double Serpentine
 F = Single Serpentine
 H = Half Serpentine
 Q = Quarter Serpentine
 S = DX Single Circuit
 I = DX Dual Circuit, Interlaced

Special

0 = None
 X = Special Pricing Authorization
 S = Steam Heating

Coating

0 = Standard
 P = Polymer E-Coating
 S = Stainless Steel Coil Casing

Controls Module Feature String Nomenclature

MODULE ID	POSITION	BLANK	BLANK	SAFETY CONTROL	BLANK	BLANK	BLANK	SPECIAL
TRA	- 101	- 0	- 00	- 0	0000	- 00000	- 0	- 0

CONTROLS MODULE DESCRIPTION

Module ID

TRA = Small

TRC = Large

Position

= Level and Position of Module in Air Handling

Unit

Blank

0 = Standard

Blank

00 = Standard

Safety Control

0 = Standard

2 = Firestat

Blank

0000 = Standard

Blank

00000 = Standard

Blank

0 = Standard

Special

0 = None

X = Special Pricing Authorization

Energy Recovery Module Feature String Nomenclature

MODULE ID	POSITION	WHEEL SIZE	RECOVERY TYPE	BLANK	BLANK	VFD CONTROL	SPECIAL
HRA	- 102	- A	- 00	- 00000	- 00000	- 0	- 0

ENERGY RECOVERY MODULE

DESCRIPTION

Module ID

HRA = AAONAIRE® Energy Recovery Wheel

Position

= Level and Position of Module in Air Handling Unit

Wheel Size

A = Standard

Recovery Type

00 = Total Energy Recovery
0A = Total Energy Recovery + 1% Purge
A0 = Sensible Only Energy Recovery
AA = Sensible Only Energy Recovery + 1% Purge

Blank

00000 = Standard

Blank

00000 = Standard

VFD Control

0 = Standard

A = VFD Controlled Wheel

Special

0 = None

X = Special Pricing Authorization

Water-Source Heat Pump Module Feature String Nomenclature

MODULE ID	POSITION	REVISION	CAPACITY	COMP	STAGING	BLANK	REFRIG OPTIONS	REFRIG ACCESS	BLANK	WATER SIDE	HEAT EXCHANGER	BLANK	SPECIAL
WHP	- 204	- A	- 25	- D	K	000	- D	A	0	H	0	- 0	- 0

WATER-SOURCE HEAT PUMP MODULE DESCRIPTION

Module ID

WHP = Water-Source Heat Pump
WCC = Water-Cooled Condenser (A/C only)

Position

= Level and Position of Module in Air Handling Unit

Revision

A

Capacity

16 = 16 tons
18 = 18 tons
20 = 20 tons
25 = 25 tons
30 = 30 tons
40 = 40 tons
50 = 50 tons
60 = 60 tons
70 = 70 tons

Compressor Style

A = R-410A Scroll Compressor
B = R-410A 2-Step Capacity Scroll Compressor
D = R-410A Variable Capacity Scroll Compressor
E = R-410A Tandem Scroll Compressor
G = R-410A Tandem Variable Capacity Scroll Compressor
J = R-454B 2 step Scroll
M = R-454B Tandem Scroll Compressor
N = R-454B Tandem Variable Capacity Scroll Compressor

Staging

G = 1 On/Off Refrigeration System
H = 1 Variable Capacity Refrigeration System
J = 2 On/Off Refrigeration Systems
K = Lead Variable Capacity Refrigeration System + Lag On/Off Refrigeration System
L = 2 Variable Capacity Refrigeration Systems
M = 2 Two Step Refrig System
N = 1 Variable Refrig System + 1 Two Step Refrig System

Blank

000 = Standard

Refrigeration Options

0 = Standard
A = Hot Gas Bypass [HGB] - Lead
B = HGB Lead + HGB Lag
C = HGB Lag

Refrigeration Accessories

0 = Standard
A = Sight Glass
B = Compressor Isolation Valves
C = Sight Glass + Compressor Isolation Valves

Blank

0 = Standard

Water-Side Options

0 = Standard
A = Balancing Valves
B = Water Flow Switch
C = Motorized Shut-off Valve
D = 2 Way Head Pressure Control
E = 3 Way Head Pressure Control
F = Options B + A
G = Options B + C
H = Options B + D
J = Options B + E
K = Options B + A + C
L = Options B + A + D
M = Options B + A + E
P = Options A + C
Q = Options A + D
R = Options A + E

Heat Exchanger Type

0 = Standard
A = SMO 254 Brazed Plate Heat Exchanger
B = Cupronickel Coaxial Heat Exchanger

Blank

0 = Standard

Special

0 = None
X = Special Pricing Authorization

Unit Orientation

Determine left hand or right hand orientation/connections:

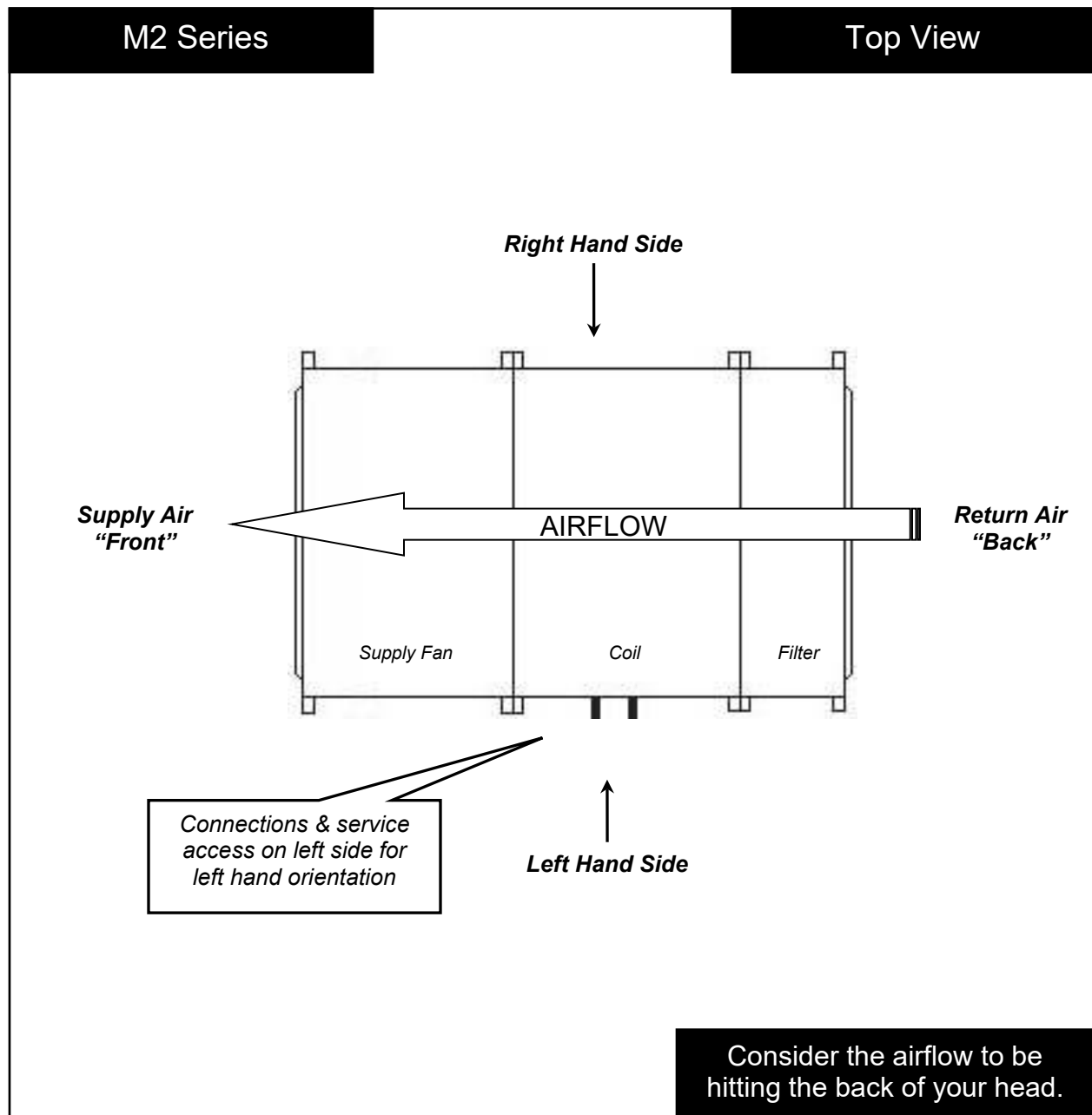

Figure 2 - Unit Orientation

General Information

M2 Series modular indoor air handling units and self-contained units have been designed for indoor installation. Flexible connectors are required on all duct connections to minimize air leaks.

M2 Series units are designed for safe operation when installed, operated and maintained within design specifications and the instructions in this manual. It is necessary to follow these instructions to avoid personal injury or damage to equipment or property during equipment installation, startup, operation and maintenance. M2 Series units are intended for installation up to 3500 meters (11,500 ft).

WARNING

Improper installation, adjustment, alteration, service, or maintenance can cause property damage, personal injury or loss of life. Startup and service must be performed by a Factory Trained Service Technician. A copy of this IOM should be kept with the unit.

CAUTION

These units must not be used for heating or cooling at any time during any phase of construction. Very low return air temperatures, harmful vapors, and misplacement of the filters will damage the unit and its efficiency.

CAUTION

This equipment is protected by a standard limited warranty under the condition that initial installation, service, startup and maintenance is performed according to the instructions set forth in this manual. This manual should be read in its entirety prior to installation and before performing any service or maintenance work.

Equipment described in this manual is available with many optional accessories. If you have questions after reading this manual in its entirety, consult other factory documentation or contact your AAON Sales Representative to obtain further information before manipulating this equipment or its optional accessories

Certification of Gas Heat Models

- a. Certified as a Category III forced air furnace with or without cooling.
- b. Certified for indoor installation.

Certification of Steam or Hot Water Heat Models

- a. Certified as a forced air heating system with or without cooling.
- b. Certified for indoor installation.

Certification of Electric Heat Models

- a. Certified as an electric warm air furnace with or without cooling.
- b. Certified for indoor installation.

Certification of Cooling Models

- a. Certified as a commercial central air conditioner.
- b. Certified for indoor installation.

- c. Certified with refrigerant R-410A coils or with chilled water cooling coils.

Codes and Ordinances

M2 Series units have been tested and certified, by ETL, in accordance with UL-1995 5th edition.

System should be sized in accordance with the American Society of Heating, Refrigeration and Air Conditioning Engineers Handbook.

Installation of M2 Series units must conform to the ICC standards of the International Mechanical Code, the International Building Code, and local building, plumbing and waste water codes. In the absence of local codes installation must conform to the current (United States) National Fuel Gas Code ANSI-Z223.1/NFPA 54 or the current (Canada) National Fuel & Propane Installation Code CSA B149.1 or B149.2, and Mechanical Refrigeration Code CSA B52. All appliances must be electrically grounded in accordance with local codes, or in the absence of local codes, the current National Electric Code, ANSI/NFPA 70 or the current Canadian Electrical Code CSA C22.1.

 WARNING
Failure to observe the following instructions will result in premature failure of your system and possible voiding of the warranty.

 CAUTION
The Clean Air Act of 1990 bans the intentional venting of refrigerant as of July 1, 1992. Approved methods of recovery, recycling, or reclaiming must be followed.

 WARNING
Coils and sheet metal surfaces present sharp edges and care must be taken when working with equipment.

Receiving Unit

When received, the unit should be checked for damage that might have occurred in transit. If damage is found it should be noted on the carrier's freight bill. A request for inspection by carrier's agent should be made in writing at once.

Nameplate should be checked to ensure the correct model sizes and voltages have been received to match the job requirements.

If repairs must be made to damaged goods, then the factory should be notified before any repair action is taken in order to protect the warranty. Certain equipment alteration, repair, and manipulation of equipment without the manufacturer's consent may void the product warranty. Contact the AAON Technical Support for assistance with handling damaged goods, repairs, and freight claims: (918) 382-6450.

Note: Upon receipt check shipment for items that ship loose such as filters and remote sensors. Consult order and shipment documentation to identify potential loose-shipped items. Loose-shipped items may have been placed inside unit cabinet for

security. Installers and owners should secure all doors with locks or nuts and bolts to prevent unauthorized access.



Figure 3 - Lockable Handle

Storage

This equipment is not suitable for outdoor use of storage. If installation will not occur immediately following delivery, store equipment in a dry protected area away from construction traffic and in the proper orientation as marked on the packaging with all internal packaging in place. Secure all loose-shipped items.

Direct Expansion (DX) Units

All factory-assembled packaged DX refrigeration systems are leak tested, charged with refrigerant, and run tested. Field-assembled and split system DX refrigeration systems are charged with a nitrogen holding charge instead of refrigerant.

All packaged water-source DX refrigerant systems include an evaporator, condenser, liquid line filter driers, thermal expansion valves (TXV) and scroll compressors.

COMPRESSOR CYCLING

! WARNING

To prevent motor overheating, compressors must cycle off for a minimum of 5 minutes.

5 MINUTE ON TIME

To maintain the proper oil level, compressors must cycle on for a minimum of 5 minutes.

The cycle rate must not exceed 6 starts per hour.

Never cut off the main power supply to the unit, except for servicing, emergency, or complete shutdown of the unit. When power is cut off from the unit, crankcase heaters cannot prevent refrigerant migration into the compressors. This means the compressor will cool down and liquid refrigerant may accumulate in the compressor. The compressor is designed to pump refrigerant gas and damage may occur when power is restored.

! CAUTION

CRANKCASE HEATER OPERATION

Some units are equipped with compressor crankcase heaters, which should be energized at least 24 hours prior to cooling operation, to clear any liquid refrigerant from the compressors.

If power to the unit must be off for more than an hour, turn the thermostat system switch to "OFF", or turn the unit off at the control

panel, and leave the unit off until the main power switch has been turned on again for at least 24 hours for units with compressor crankcase heaters. This will give the crankcase heater time to clear any liquid accumulation out of the compressor before it is started.

Always control the unit from the thermostat, or control panel, never at the main power supply, except for servicing, emergency or complete shutdown of the unit.

During the cooling season, if the air flow is reduced due to dirty air filters or any other reason, the cooling coils can get too cold which will cause excessive liquid to return to the compressor. As the liquid concentration builds up, oil is washed out of the compressor, leaving it starved for lubrication.

The compressor life will be seriously shorted by reduced lubrication and the pumping of excessive amounts of liquid oil and refrigerant.

 CAUTION
<p>Polyolester (POE) and Polyvinylether (PVE) oils are two types of lubricants used in hydrofluorocarbon (HFC) refrigeration systems. Refer to the compressor label for the proper compressor lubricant type.</p>

Note: Low Ambient Operation

Air-cooled DX units without a low ambient option, such as condenser fan cycling, ECM driven condenser fans or the -17.8°C (0°F) low ambient option, will not operate in the cooling mode of operation properly when the outdoor temperature is below 12.8°C (55°F). Low ambient and/or economizer options are recommended if cooling operation below 12.8°C (55°F) is expected.

Note: Multiple Units with Multiple Thermostats

When several heating and cooling units are used to condition a space, all unit thermostat switches must be set in either heating mode, cooling mode, or off. Do not leave part of the units switched to the opposite mode. Cooling only units should be switched off at the thermostat during the heating season.

Gas or Electric Heating

The unit is designed to heat a given amount of air while operating. If this amount of air is greatly reduced, approximately 1/3 during the heating season, the gas heat exchanger or electric heating coil may overheat, and may cut the burner or heater off entirely by action of the safety high temperature limit devices which are factory mounted at the heat exchanger and supply fan areas.

Airflow should be adjusted after installation to obtain an air temperature rise within the range specified on the unit rating plate at the required external static pressure.

Should overheating occur with a gas heat exchanger, or the gas supply fail to shut off, shut off the manual gas valve to the furnace before shutting off the electrical supply.

Prolonged overheating of the heat exchanger will shorten its life.

The maximum supply air temperature is 60°C (140°F).

Wiring Diagrams

Unit specific wiring diagrams are laminated and affixed inside the controls compartment door.

Condensate Drain Pan

Unit requires drain traps to be connected to the condensate drain pan of the unit.

For condensate drain lines, the line should be the same pipe size or larger than the drain connection, include a p-trap, and pitch downward toward drain. An air break should be used with long runs of condensate lines. See Installation section of this manual for more information.

! CAUTION
 Unit should not be operated without a p-trap. Failure to install a p-trap may result in overflow of condensate water.

! CAUTION
 An auxiliary / emergency drain pan is recommended for all indoor applications where there is a risk of water damage to surrounding structure or furnishings. Refer to local codes.

Table 1 – Electric and Gas Heating Capacities

	Gas Heat		Electric Heat	
	Input Capacity	Output Capacity	Capacity	
	MBH	MBH	kW (230V, 460V, 575V)	kW (208V)
0 = Hot Water				
A = Heat A	300	240	7	5.3
B = Heat B	350	280	14	10.5
C = Heat C	400	320	21	15.8
D = Heat D			28	21.0
E = Heat E			42	31.5
F = Heat F			56	42.0
G = Heat G			70	52.5
H = Heat H			35	26.3
J = Heat J			84	63.0
K = Heat K			112	84.1
L = Heat L			126	94.6
M = Heat M			168	126.2
N = Heat N			10	7.5
P = Heat P			20	15.0
Q = Heat Q			30	22.5
R = Heat R			40	30.0
S = Heat S			50	37.5
T = Heat T			80	60.1
U = Heat V			100	75.1
V = Heat V			120	90.1
W = Heat W			160	120.1
1 = Heat 1	50	40		
2 = Heat 2	75	60		
3 = Heat 3	100	80		
4 = Heat 4	125	100		
5 = Heat 5	150	120		
6 = Heat 6	175	140		
7 = Heat 7	200	160		
8 = Heat 8	250	200		

Installation

The M2 can either be shipped assembled or shipped in individual modules. See the Module Assembly section of this document for instructions on individual modules.

WARNING

Improper installation, adjustment, alteration, service, or maintenance can cause property damage, personal injury or loss of life. Startup and service must be performed by a Factory Trained Service Technician. A copy of this IOM should be kept with the unit.

Locating Units

Verify foundation or mounting frame can support the total unit weight, including accessory weights.

Before setting the unit into place, caution must be taken to provide clearance for unit doors that must be accessible for periodic service. These areas contain the controls, safety devices, refrigerant or water piping, shut-off valves and filters.

A minimum clearance equal to the width of the unit is required on the access panel side of the unit to ensure there is enough room to slide out coils and energy recovery wheels, and to access filters, fans and other internal components.

WARNING

When locating gas fired units, it is recommended the unit be installed so that the flue discharge vents are located at least 305 cm (120 inches) away from any opening through which combustion products could enter the building.

WARNING

Distances from adjacent public walkways, adjacent buildings, operable windows and building openings, shall conform to local codes and/or the National Fuel Gas Code, ANSI Z223.1/NFPA 54, or the National Gas & Propane Code, CSA B149.1

For gas fired unit, do not position flue opening to discharge into a fresh air intake of any other piece of equipment. Unit should also be installed so that the flow of combustion intake air is not obstructed from reaching the furnace.

Flue gas is dangerously hot and contains contaminants. The user is responsible for determining if vent gases may degrade building materials.

The National Gas and Propane Installation Code, B149.1 specifies a 1.8 m (6 ft) horizontal vent terminal clearance to gas and electric meters and relief devices.

Local codes may supersede or further place restrictions on vent termination locations.

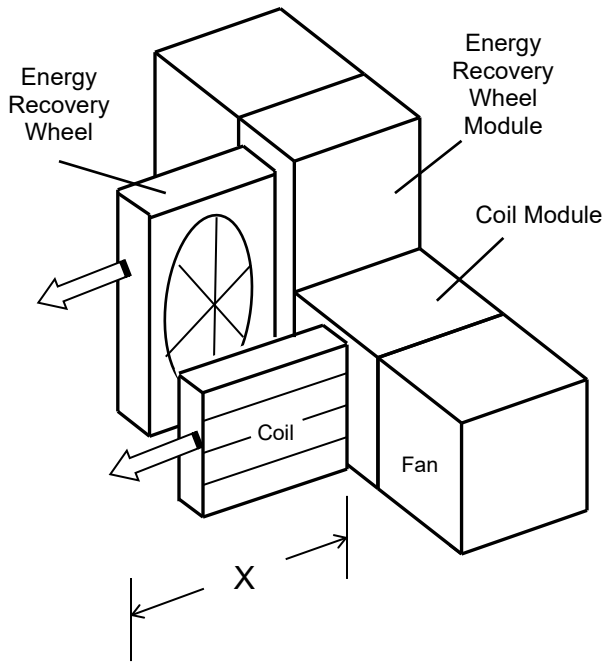

Figure 4 - Service Access Clearance

Table 2 - Minimum Clearances

Unit Size	Minimum Required Service Clearance X =
M2-018	84"
M2-026	84"
M2-036	96"

Lifting the Assembled Unit

Units may be delivered as separate modules or completely factory assembled with all modules connected. In the latter case, if the unit was received fully assembled, the recommended method of lifting is to insert a 38.1 mm (1-1/2") steel pipe through the lifting lugs along the entire length of the unit, then pick the unit up using a spreader bar assembly. Refer to Figure 5 - M2 Series Unit Four Point Lifting and Figure 6 - M2 Series Unit Eight Point Lifting.

CAUTION

UNIT HANDLING

To prevent injury or death lifting equipment capacity shall exceed unit weight by an adequate safety factor. Always test-lift unit not more than 61 cm (24 inches) high to verify proper center of gravity lift point to avoid unit damage, injury or death.

If cables or chains are used to hoist the unit they must be the same length. Care should be taken to prevent damage to the cabinet, coils and condenser fans.

Before lifting unit, be sure that all shipping material has been removed from unit.

CAUTION

Incorrect lifting can cause damage to the unit.

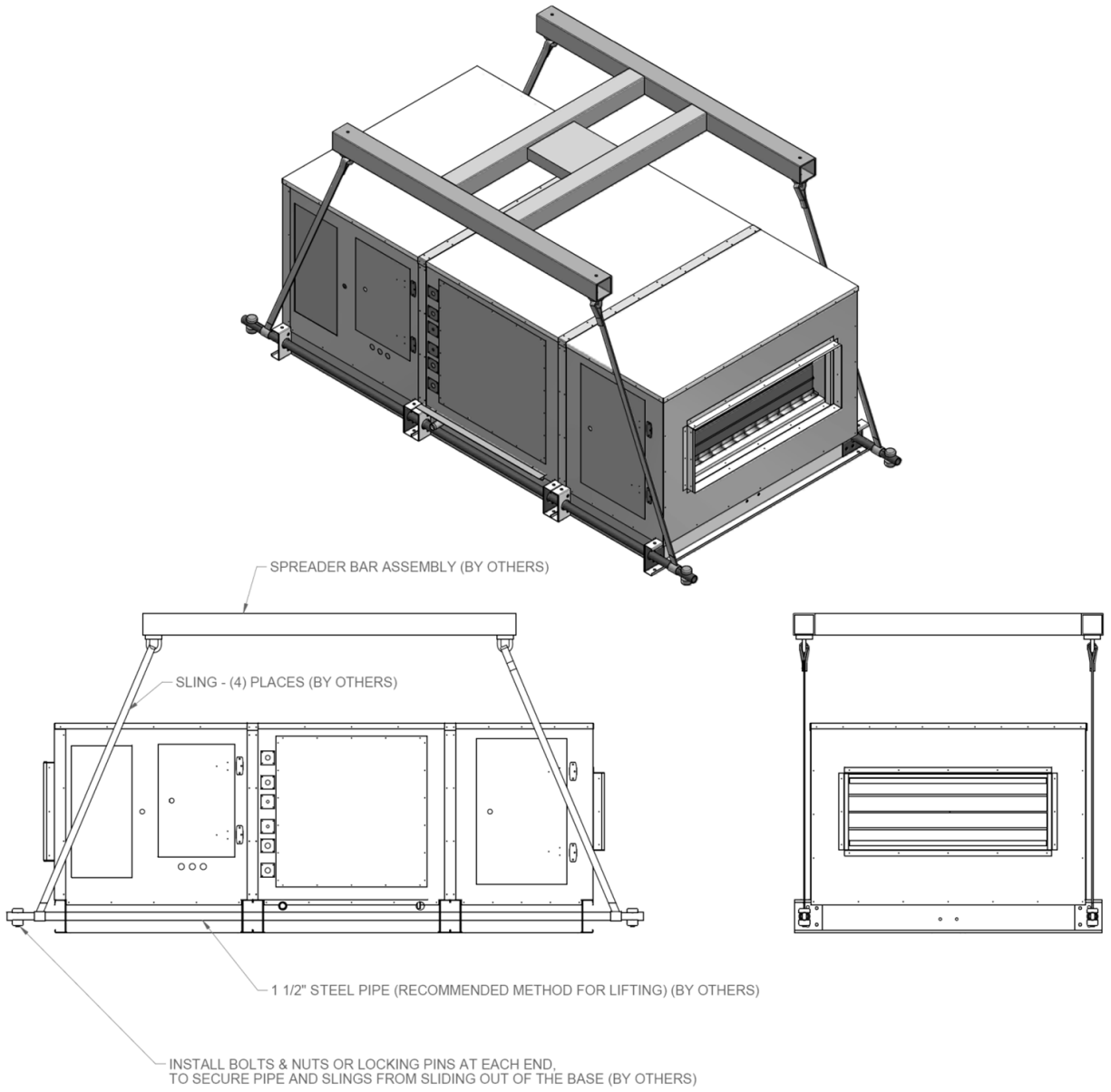

Figure 5 - M2 Series Unit Four Point Lifting

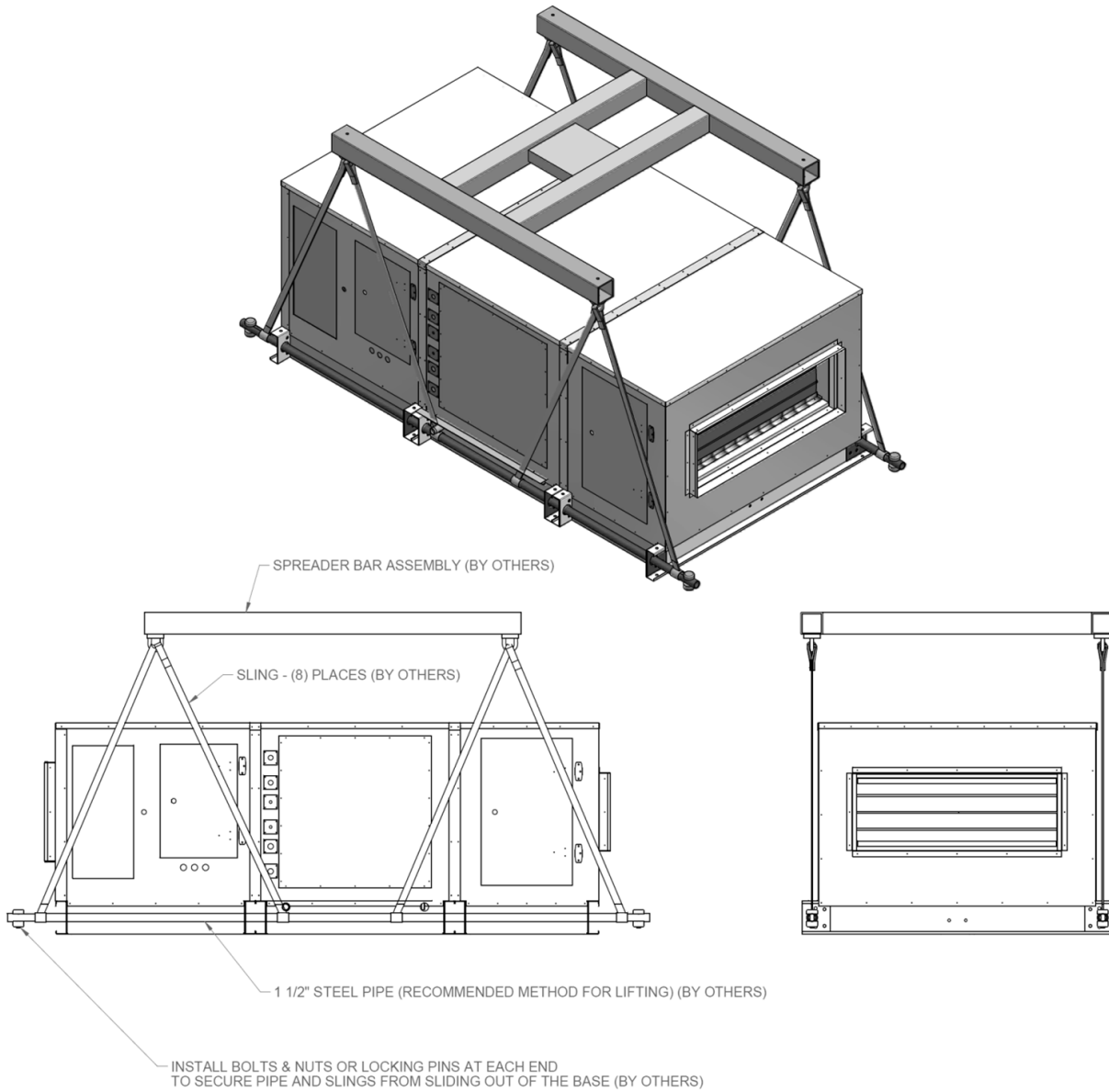

Figure 6 - M2 Series Unit Eight Point Lifting

Lifting the Individual Modules

The bottom tier individual modules have lifting lugs built into the base. Individual bottom tier modules can be lifted by securing hooks and cables at all four lugs provided on the module.

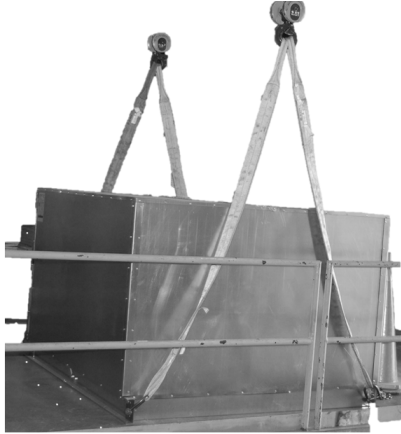

Figure 7 - M2 Series Individual Module Bottom Tier Lifting

The top tier individual modules are shipped on individual wooden pallets and do not have base lifting lugs. They can be lifted by wrapping a strap around each side of the module or using a forklift truck.



Figure 8 - M2 Series Individual Module Top Tier Lifting

Floor Mounted Units

Dual path units, self-contained units and units over size M2-018 must be floor mounted. Make sure the unit is level, and installed with a minimum height of 15.25 cm (6") to allow for proper drainage of the condensate line. Standard units are built with a 15.25 cm (6"). Other installation provisions may be necessary according to job specifications.

A ceiling suspended mounting frame must be provided for unit suspension. It is the responsibility of the engineer or installing contractor to design and build a suitable structure based on the load distribution of individual modules. C-channels, or similar structural members, are suggested to be placed parallel to airflow under each base rail of the unit, with appropriate structural cross members as required by weight and design. A 4" minimum c-channel size is recommended. The unit is not designed to be suspended directly from the base rails. An appropriate structural support is required for suspension.

The air handling unit must be installed level as the internal drain pan is manufactured with a slope toward the drain. Other installation provisions may be necessary according to job specifications and requirements.

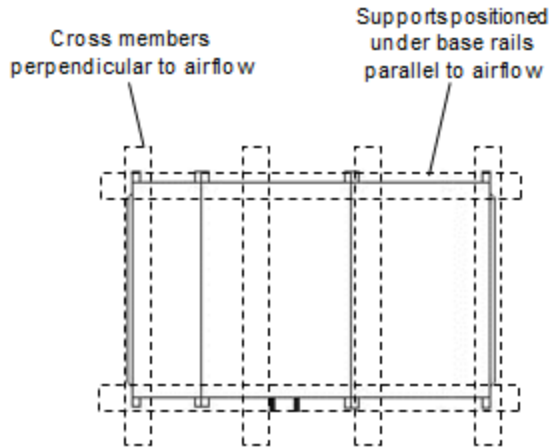

Module Assembly

Although M2 Series modular units are shipped factory assembled as standard, the unit may be ordered as individual modules for certain applications such as for assembly in existing structures where modules must be manipulated separately. If the unit was ordered as individual modules, then they must be connected in the field.

Locate the configuration schematic in the equipment's literature packet. The schematic will have *CONFIGURATION* written in the top left hand corner followed by the unit model number and then the module configuration numbers listed in order.

1. Identify and Situate Modules

Use the Feature String descriptions at the beginning of this manual or in the M2 Engineering Catalog for assistance identifying module types by their three-letter codes.

It is advisable to situate all required modules in the installation location as near as possible to the order in which they will be connected. Be sure to leave enough space to work between modules before connection.

Identify each module by the configuration number on its label. For example, if a module has a configuration number of FTF-101-P-

A0-00000-00000-0-0, then it is a large flat filter module "FTF", and should be placed in the first position "101" of the lower tier - the bottom left as you face the access side of a right hand unit, or the bottom right as you face the access side of a left hand unit.

Although the schematic should be available, the configuration numbers have been created so that correct assembly order can be determined without the need for a schematic.

Modules are arranged in order with 100 series modules on the first tier and 200 series modules on the second tier. Module 101 will always be located on the end of the bottom tier - the bottom left as you face the access side of a right hand unit, or the bottom right as you face the access side of a left hand unit. Module 201 will always be located on the end of the top tier - the top left as you face the access side of a right hand unit, or the top right as you face the access side of a left hand unit. Therefore, it is possible to identify the exact module arrangement even without knowing the module type, and without a configuration schematic.

If, for any reason, a module or its position in final assembly is unidentifiable, then consult the project engineer, AAON sales representative, or AAON Technical Support (918) 382-6450.

After identifying modules and determining module arrangement, modules can be prepared for final assembly.

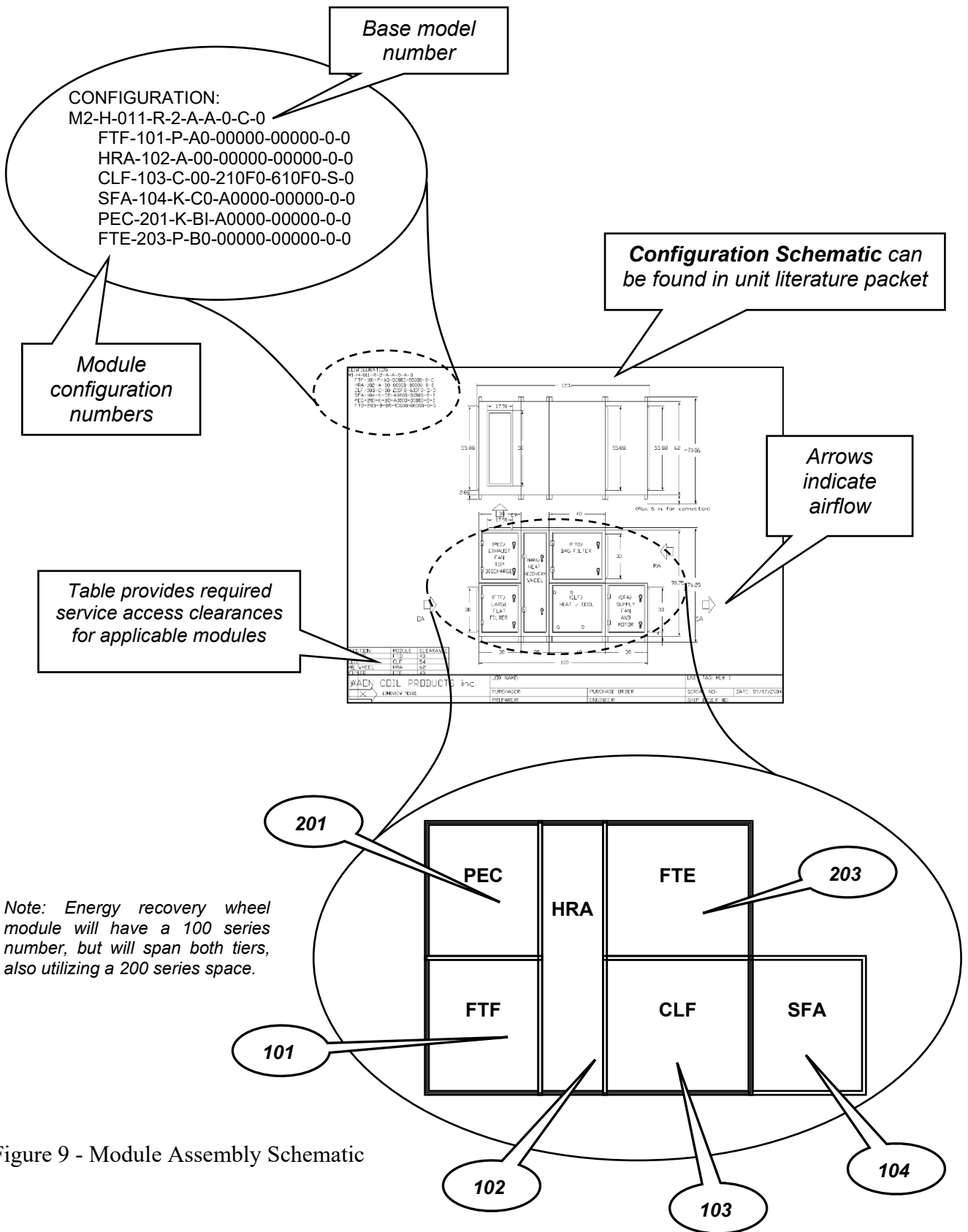

Figure 9 - Module Assembly Schematic

2. Connect Modules

Modules are to be connected with nuts and bolts through the base rail with a strong metal casing around the bolt. (see Figure 11 below). The walls and roof are connected with metal strapping over module joints. Metal straps have adhesive backs and are to be additionally fastened to the unit case with sheet metal screws. All connection hardware is shipped with the unit.

Align modules and place the metal support bolt casing in the middle of the two bases. Insert bolts through the bolt hole, through the metal support casing, and through the second bolt hole in the base rails of two adjacent modules. Secure with nuts to pull the bases of the two modules together tightly.

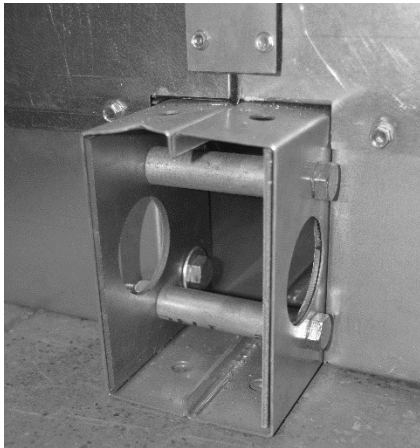

Figure 10 - Bolted Base Rail

Use bar clamps or other non-destructive winching device to pull the tops of the modules together tightly.



Figure 11 - Bar Clamp

There should now be an airtight joint that needs to be permanently secured in position.

3. Secure Module Joints

The metal straps are to be used to secure module joints in order to maintain the airtight seal. Straps are provided with pre-drilled holes and adhesive backing already affixed. Self-tapping sheet metal screws are provided to attach the straps to the unit cabinet.

Leave bar clamps in place until strap is secure.

Peel away backing from adhesive side of a strap.

Place the strap over a module joint with the adhesive side of the strap against the unit case.

Ensure that strap completely covers the joint and that it is square with the unit casing.

Apply pressure to the strap to affix the adhesive and to hold strap in place.

Insert self-tapping screws through pre-drilled holes in strap and secure screws into unit casing using a power drill. For best results, use the lowest effective power drill torque setting. Be careful not to over tighten the screws.

Remove bar clamps and repeat for all remaining module joints.

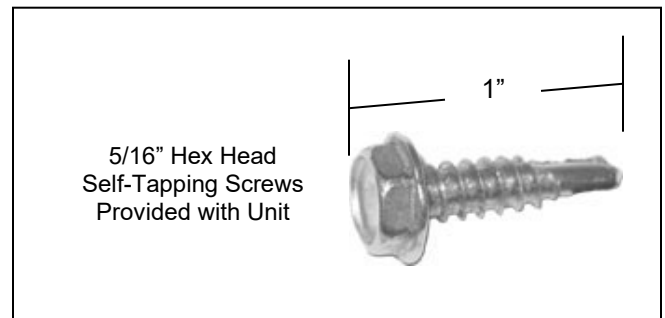

Figure 12 - Self-Tapping Screw

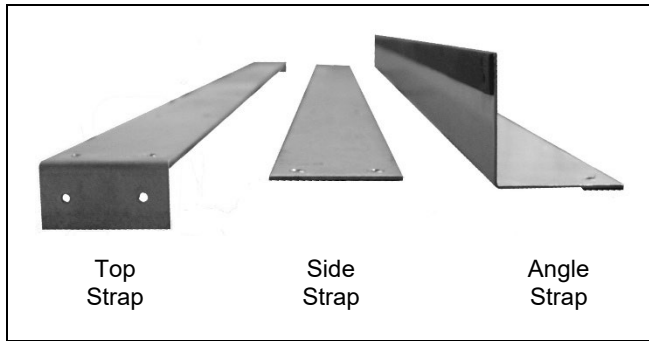

Figure 13 - Strap Types

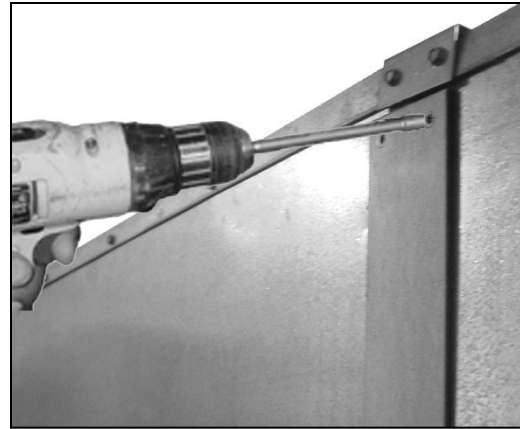

Figure 16 - Strap Installation

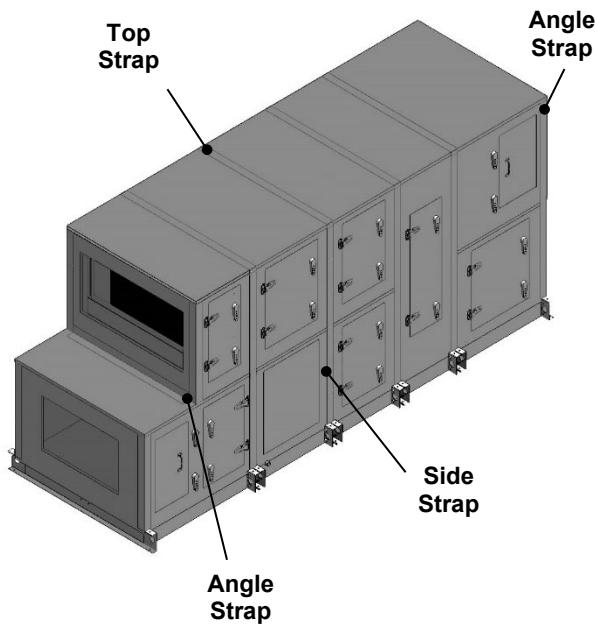

Figure 14 - Strap Locations

4. Run Power and Control Wiring
M2 Series units are equipped with an internal wiring chase, located along the inside top of each module. Wire is provided for power and control wiring inside the unit.



Figure 17 - Power and Control Wiring



Put straps in position, hold in place and attach with self-tapping sheet metal screws.

Figure 15 - Strap Positioning



Figure 18 - Quick Connects

Wire from the unit to external controls and power sources must be provided in the field.

A color-coded wiring diagram is laminated and affixed to the inside of the control compartment access door. M2 Series units are equipped with a single point power connection.

5. Final Sealing

It is very important to keep air from infiltrating the unit cabinet. Seal all piping penetrations with Armaflex, Permagem or other suitable sealant. Also seal around drain connections, electrical connections and all other inlets where air may enter the cabinet. This is especially important when the unit is installed in an unconditioned area.

Evaporator Coils

The air handling unit coils are pressurized. The copper caps must be punctured to permit a gradual escape of the pressure prior to unsweating those caps. Immediately couple the tubing to the indoor unit to avoid exposing the coils to moisture. A properly sized filter drier is furnished in the condenser. When making solder connections, make sure dry nitrogen flows through the lines, when heating the copper, to prevent oxidization inside of the copper.

Field piping between the condensing unit and the air handler is required.

Thermal expansion valve bulbs should be mounted with good thermal contact on a horizontal section of the suction line close to the evaporator, but outside the cabinet, and well insulated. On suction lines less than or equal to 22 mm (7/8") OD, mount in the 12 o'clock position. On suction lines greater than 22 mm (7/8"), mount in either the 4 o'clock or 8 o'clock position.

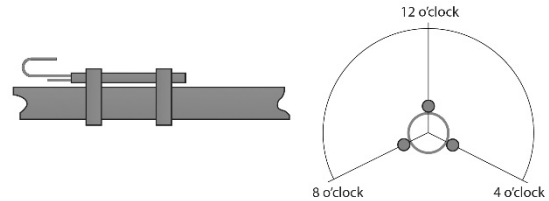

Figure 19 - TXV Bulb Position

Hot Gas Reheat

Hot Gas Reheat (HGRH) is available for use with DX systems that need humidity control. The AAON modulating hot gas reheat system diverts hot discharge gas from the condenser to the air handling unit through the hot gas line.

Field piping between the condensing unit and the air handler is required. Connect the hot gas line from the outdoor unit to the upper stub-out connection of the reheat coil in the air handling unit.

The line delivers the hot discharge gas to the reheat coil and/or the hot gas bypass valve, so it is sized as a discharge line.

Hot Gas Bypass

Hot Gas Bypass (HGB) is available for use with DX systems that may experience low suction pressure during the operating cycle. This may be due to varying load conditions associated with VAV applications or units supplying a large percentage of outside air. Hot Gas Bypass is not necessary in units with variable capacity compressors. The system is designed to divert refrigerant from the compressor discharge to the low pressure side of the system in order to keep the evaporator from freezing and to maintain adequate refrigerant velocity for oil return at minimum load.

Hot discharge gas is redirected to the evaporator inlet via an auxiliary side connector (ASC) to false load the evaporator when reduced suction pressure is sensed. **Field piping between the condensing unit and the evaporator is required.**

Refrigerant-to-Water Heat Exchanger
Condenser water pump, condenser water piping, cooling tower, pressure gauges, strainers and all components of the waterside piping must be field installed.

 CAUTION
WATER-SOURCE HEAT PUMP APPLICATIONS
Water-source heat pump units using 100% outside air must have electric preheat if the application has a potential for heat pump heating operation with air entering the indoor coil below 4.4°C (43°F) with an entering water loop temperature of 21.1°C (70°F).

Open Loop Applications
This product contains one or more refrigerant-to-water heat exchangers made of 316 Stainless Steel. 316 Stainless Steel is subject to severe corrosion and failure when exposed to chlorides.

 WARNING
OPEN LOOP APPLICATIONS
Failure of the condenser as a result of chemical corrosion is excluded from coverage under AAON Inc. warranties and the heat exchanger manufacturer's warranties.

Do not allow water containing any form of chlorides to enter this heat exchanger.

Common forms of chlorides include:

1. Sea water mist entering an open cooling tower system.
2. Contaminated make-up water containing salt water.
3. Disinfection the water loop with solutions containing sodium hypochlorite.

Chlorides will result in a premature failure of the condenser.

 WARNING
OPEN LOOP APPLICATIONS
SMO 254 brazed plated refrigerant-to-water heat exchangers are recommended with all open loop applications. Failure to use a SMO 254 heat exchanger may result in premature failure of your system and possible voiding of the warranty.

Failure of the condenser as a result of chemical corrosion is excluded from coverage under AAON warranties and the heat exchanger manufacturer warranties.

Failure of the condenser will allow water to enter the refrigerant circuit and will cause extensive damage to the refrigerant circuit components. Any damage to the equipment as a result of condenser failure from chemical corrosion due the fluid in the condenser is excluded from coverage under AAON warranties and the heat exchanger manufacturer warranties.

! CAUTION

Cleaning the cooling tower or condenser water loop with harsh chemicals such as hydrochloric acid (muriatic acid), chlorine or other chlorides, can damage the refrigerant-to-water heat exchanger. Care should be taken to avoid allowing chemicals to enter the refrigerant-to-water heat exchanger. See Appendix A - Heat Exchanger Corrosion Resistance for more information.

Freezing Water in the Heat Exchanger

This product contains one or more refrigerant-to-water heat exchangers. A refrigerant-to-water heat exchanger contains refrigerant in one passage and water in another passage. Water is subject to freezing at 0°C (32°F). When water freezes in a heat exchanger significant forces are exerted on the components of the heat exchanger where the water is confined.

! WARNING

WATER FREEZING

Failure of the condenser due to freezing will allow water to enter the refrigerant circuit and will cause extensive damage to the refrigerant circuit components. Any damage to the equipment as a result of water freezing in the condenser is excluded from coverage under AAOB warranties and the heat exchanger manufacturer warranties.

Unit is capable of operating with Entering Water Temperatures (EWT) as low as 13.9 °C (57°F) during cooling mode without the need for head pressure control. If the EWT is expected to be lower than 13.9 °C (57°F) or more stable operation is desired, a factory provided head pressure control water valve option is available.

Glycol solution should be used if ambient temperatures are expected to fall below freezing or if the loop water temperature is below 10°C (50°F) while operating in the heating mode (heat pump units only). Adding glycol to condenser water causes an increase in pressure drop resulting in a decrease in unit performance. A minimum concentration of 20% glycol solution is recommended.

Table 3 - Glycol Freezing Points

% Glycol	Ethylene Glycol [°C (°F)]	Propylene Glycol [°C (°F)]
20	-7.8 (18)	-7.2 (19)
30	-13.9 (7)	-12.8 (9)
40	-21.7 (-7)	-21.1 (-6)
50	-33.3 (-28)	-32.8 (-27)

Water loop piping runs through unheated areas or outside the building should be insulated.

Water Piping

All *water-source heat pump* units are built with a water flow switch. Some *water-cooled* units may not have a water flow switch. This sensor provides a signal to the unit controller that water flow is present in the heat exchanger and the compressors can operate without damaging unit components. Installing contractor must ensure a differential pressure switch is installed between the condenser water supply and return connections if the unit does not have a water flow switch installed at the factory.

The water connections will differ depending on whether the unit is water-cooled only or if it is water-source heat pump. The water-source heat pump units have water supply to the top of the heat exchanger and the return to the bottom.

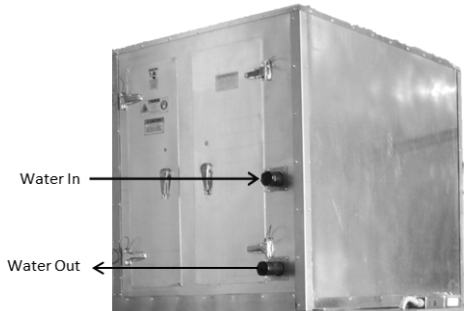

Figure 20 - Water-Source Heat Pump Water Piping

The water-cooled only units have water supply to the bottom of the heat exchanger and the return to the top.

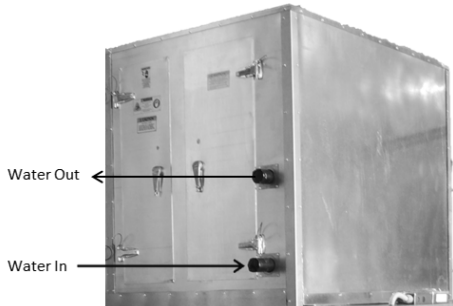

Figure 21 - Water-Cooled Only Water Piping

! WARNING

WATER PRESSURE

Prior to connection of condensing water supply, verify water pressure is less than maximum pressure shown on unit nameplate. To prevent injury or death due to instantaneous release of high pressure water, relief valves should be field supplied on water piping. Supply water connection may require a backflow preventer to prevent supply makeup water from backing up into the public water system.

Condenser water connections range in size from 25.4-76.2 mm (1"-3") OD copper or black pipe. Only use approved water pipe material. Avoid using galvanized material for water lines/fittings as the material is corrosive and may cause fouling of the water system.

Table 4 - Standard Water-Source Connections

Tonnage	Supply and Return Connection Size
016, 018, 020	51mm (2") SCH 40 black pipe
025, 030, 040, 050	63.5mm (2-1/2") SCH 40 black pipe
060, 070	76mm (3") SCH 40 black pipe

Condenser water pump must be field sized and installed between the cooling tower and self-contained unit. System should be sized in accordance with the ASHRAE Handbook. Use engineering guidelines to maintain equal distances for supply and return piping and limit bend radiuses to maintain balance in the system. Balancing valves, permanent thermometers and gauges may be required.

! CAUTION

Proper sealing of the water piping entries into the unit must be ensured before operation. Failure to seal the entries may result in damage to the unit and property.

! CAUTION

PVC (Polyvinyl Chloride) and CPVC (Chlorinated Polyvinyl Chloride) are vulnerable to attack by certain chemicals. Polyolester (POE) oils used with R-410A and other refrigerants, even in trace amounts, in a PVC or CPVC piping system will result in stress cracking of the piping and fittings and complete piping system failure.

! CAUTION

WATER PIPING

Follow national and local codes when installing water piping. Connections to the unit should incorporate vibration eliminators to reduce noise and vibration and shutoff valves to facilitate servicing. Supply and return water piping must be at least as large as the unit connections and larger depending on length of runs, rise and bends.

Before connection to the unit the condenser water system should be flushed to remove foreign material that could cause condenser fouling. Install a screen strainer with a minimum of 20 Mesh ahead of the condenser

inlet to prevent condenser fouling and internal tube damage.

Mineral content of the condenser water must be controlled. All make-up water has minerals in it and as the water is evaporated in the cooling tower, these minerals remain. As the mineral content of the water increases, the conductivity of the water increases.

Field provided and installed water treatment program must be compatible with stainless steel, copper, aluminum, ABS plastic, and PVC. Batch feed processes should never be used as concentrated chemicals can cause corrosion. Never use hydrochloric acid (muriatic acid) or chlorine as it will corrode stainless steel.

! CAUTION

Each heat exchanger is equipped with a refrigerant pressure relief device to relieve pressure should excessive condensing pressures (>4654 kpa [675 psig]) occur. Codes may require installing contractor to connect and route relief piping outdoors. The relief valve has a 16 mm (5/8") male flare outlet connection.

Unit is capable of operating with Entering Water Temperatures (EWT) as low as 10°C (50°F) without the need for head pressure control. If the EWT is expected to be lower than 10°C (50°F) or more stable operation is desired, a field provided water regulating valve may be used.

Glycol solution should be used if ambient temperatures are expected to fall below freezing or if the loop water temperature is below 10°C (50°F) while operating in the heating mode (heat pump units only). Adding

glycol to condenser water causes an increase in pressure drop resulting in a decrease in unit performance. A minimum concentration of 20% glycol solution is recommended. Reference Table 3.

Piping systems should not exceed 10 ft/sec velocity to ensure tube wall integrity and reduce noise.

! CAUTION

Do not exceed recommended condenser fluid flow rates. Serious damage to or erosion of the heat exchanger tubes could occur.

Heat Exchanger Safeties

Electronic freeze protection and water flow safeties should be field installed or factory provided. If the leaving water temperature drops below 3.3 °C (38°F) or water flow has ceased the 24VAC control circuit will be broken to disable the cooling system.

Waterside Economizer

Cooling and pre-cooling waterside economizer coil is factory installed upstream of the evaporator coil. An optional field installed water piping kit includes three fully modulating water valves (the economizer valve, economizer bypass valve, and a three-way head pressure control valve). The water piping between the waterside economizer and the water-cooled condenser must be field provided. See the waterside economizer piping figure for recommended piping.

A p-trap must be installed on the coil drain outlet, not to exceed 15.25 cm (6") from the drain connection. See the previous section on condensate drain piping for additional p-trap and drain information.

! CAUTION

DRAIN PAN CONNECTION

With a waterside economizer coil a separate drain connection is included. Failure to use this separate drain connection may result in water backup and overflow of drain pan.

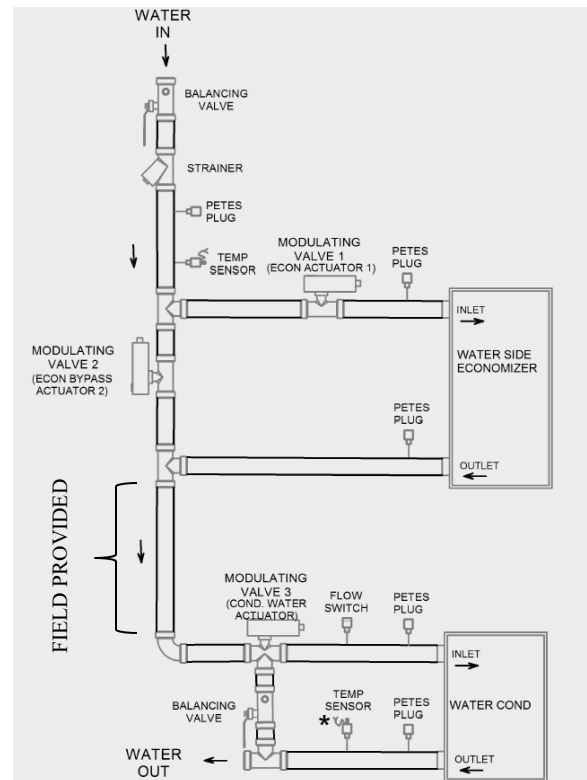

Figure 22 – Waterside Economizer Piping

The waterside economizer circuit can operate in three modes: waterside economizer only, waterside economizer with mechanical cooling, and mechanical cooling only.

During waterside economizer only mode of operation, condenser water flows through the waterside economizer coil with modulating valves maintaining supply air temperature setpoint. The condenser water completely bypasses the water-cooled condenser.

During waterside economizer with mechanical cooling mode of operation, 100% of the condenser water flows through the waterside economizer coil. The condenser water then passes through the water-cooled condenser and the three-way valve modulates to maintain head pressure.

During mechanical cooling only mode of operation, condenser water flows around the waterside economizer coil with the waterside economizer bypass valve fully open. The condenser water then passes through the water-cooled condenser and the valves modulate to maintain head pressure.

Mineral content of the condenser water must be controlled. All make-up water has minerals in it and as the water is evaporated in the cooling tower, these minerals remain. As the mineral content of the water increases, the conductivity of the water increases.

Field provided and installed water treatment program must be compatible with stainless steel, copper, aluminum, ABS plastic, and PVC. Batch feed processes should never be used as concentrated chemicals can cause corrosion. Never use hydrochloric acid (muriatic acid) or chlorine as it will corrode stainless steel.

Heating Coils

One or two row hot water heating coils can be factory mounted. These coils are supplied from a building hot water source. The hot water coil is not connected to the water-source condenser piping. All controls for heating operation are field supplied and field installed.

Always connect the steam heating supply to the top of the coil and the return to the bottom.

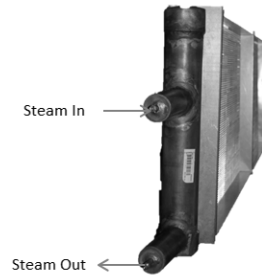

Figure 23 - Steam Distributing Piping

Table 5 – Steam Distributing Coil Sweat Connection Sizes (OD)

Model (M2-)	Supply and Return Connection Size
018- 036	54mm (2 1/8")

Air handling units with steam heating coils **MUST BE** installed high enough to allow for a minimum of 1 foot condensate drop leg off of the steam coil, or as recommended by the steam trap manufacturer. Lines should be insulated with approved insulation and be properly fastened, sloped, and supported according to local code requirements.

Table 6 – Hot Water Coil Sweat Connection Sizes (OD)

Model (M2-)	Supply and Return Connection Size
018	54 mm (2 1/8")
026, 036	67 mm (2 5/8")

Always connect the hot water heating supply to the bottom of the coil and return to the top.

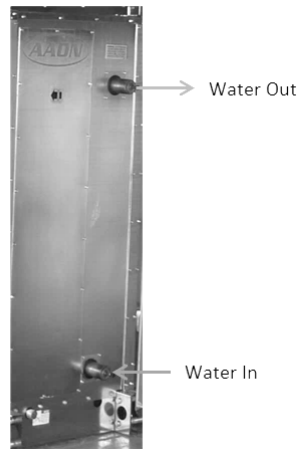

Figure 24 - Hot Water Piping

Water coils should not be subjected to entering air temperatures below 3.3°C (38°F) to prevent coil freeze-up. If air temperature across the coil is going to be below this value, use a glycol solution to match the coldest air expected.

Water supply lines must be insulated, properly fastened, drained, and supported according to local code requirements.

Chilled Water Coils

Four, six, or eight row chilled water cooling coils can be factory mounted. These coils are supplied from a building chilled water source. The chill water coil is not connected to the water-source condenser piping. All controls for the cooling coil are field supplied and field installed.

Table 7 – Chilled Water Coil Sweat Connection Sizes (OD)

Model (M2-)	Supply and Return Connection Size
018,	67 mm (2 5/8")
026, 036	79.4 mm (3 1/8")

Always connect the chilled water supply to the bottom of the coil and return to the top.

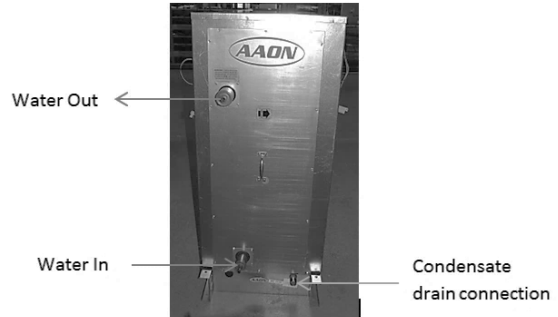

Figure 25 - Chill Water Piping

Water supply lines must be insulated with closed cell type pipe insulation or insulation that includes a vapor barrier. Lines should be properly fastened, drained and supported according to local code requirements, and job specifications.

! WARNING

Piping shall be in accordance with national and local codes. Pressure limiting devices, backflow preventers and all other safety requirements are the sole responsibility of the installing contractor.

Condensate Drain Piping

Unit may be equipped with more than one condensate drain pan connection. A p-trap and drain line must be installed on every drain connection, with the p-trap not to exceed 15.25 cm (6") from the drain connection. The lines should be the same pipe size or larger than the drain connection, include a p-trap, and pitch downward toward drain. An air break should be used with long runs of condensate lines.

! CAUTION

Unit should not be operated without p-traps. Failure to install a p-trap may result in overflow of condensate water.

Draw-through cooling coils will have a negative static pressure in the drain pan area. This will cause an un-trapped drain to back up due to air being pulled up through the condensate drain piping. Blow-through coils will have a positive static pressure in the drain pan. The condensate piping on these drain pans must be trapped to prevent pressure loss through the drain.

Condensate drain trapping and piping should conform to all applicable governing codes.

Note: The drain pan connection is a 25 mm (1") MPT fitting.

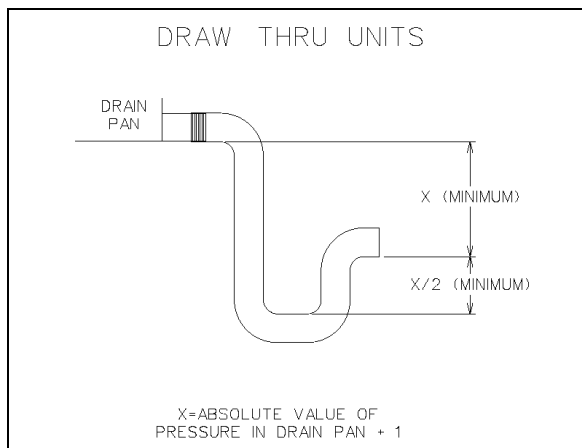

Figure 26 - Draw-Through Drain Trap

Table 8 – Draw-Through and Blow-Through Drain Trap Dimensions (Metric)

Draw-Through		
Drain Pan Pressure	Trap Dimensions	
Negative Static	X	X/2
(mmHg)	(millimeters)	(millimeters)
-0.93	38.1	19.1
-1.87	50.8	25.4
-2.80	63.5	31.8
-3.74	76.2	38.1
-4.67	88.9	44.5
-5.60	101.6	50.8
-6.54	114.3	57.2
-7.47	127	63.5

Table 9 – Draw-Through and Blow-Through Drain Trap Dimensions (Imperial)

Draw-Through		
Drain Pan Pressure	Trap Dimensions	
Negative Static	X	X/2
(inches of water)	(inch)	(inch)
-0.50	1.50	0.75
-1.00	2.00	1.00
-1.50	2.50	1.25
-2.00	3.00	1.50
-2.50	3.50	1.75
-3.00	4.00	2.00
-3.50	4.50	2.25
-4.00	5.00	2.50

The X dimension on the draw-through trap should be at least equal to the absolute value of the negative static pressure in the drain pan plus one inch. To calculate the static pressure at the drain pan add the pressure drops of all components upstream of the drain pan, including the cooling coil, and add the return duct static pressure. Include the dirt allowance pressure drop for the filters to account for the worst-case scenario.

The height from top of the bottom bend of the trap to the bottom of the leaving pipe must be at least equal to one half of the X dimension. This ensures that enough water is stored in

the trap to prevent losing the drain seal during unit startup

Note: The absolute value of the fan inlet pressure will always be greater than or equal to the absolute value of the static pressure in the drain pan on draw-through units, so the fan inlet pressure is a safe value to use for the drain pan static pressure.

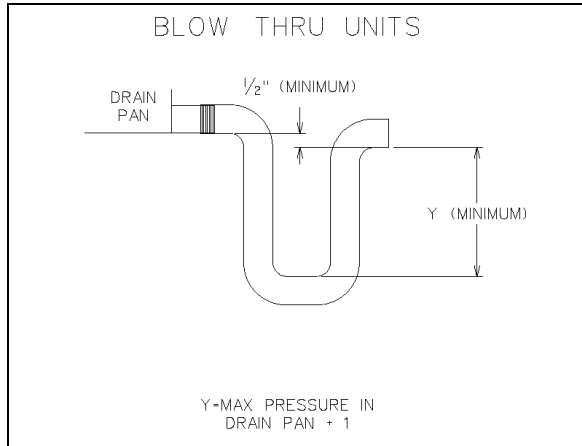

Figure 27 - Blow-Through Drain Trap

The Y dimension of blow-through traps should be at least equal to the value of the positive pressure in the drain pan plus one inch. Reference Table 9 and Table 10 for trap dimensions based on positive static value. This ensures that there will be enough water stored in the trap to counter the static pressure in the drain pan. To find the pressure subtract any pressure drops between the drain pan and the supply blower from the blower discharge pressure. The worst-case scenario for blow-through coils is the minimum pressure drop, so do not include dirt allowance pressure drops for filters.

The bottom of the leaving pipe should be at least one half inch lower than the bottom of the drain pan connection. This ensures proper drainage when the unit is not running.

Note: It may be necessary to fill the trap manually, or the trap can be filled

automatically by operating the unit until enough condensate collects to fill the trap. The trap will then be filled when the unit is turned off.

Blower Wheels

M2 Series units are equipped with backward curved blower wheels that are set to deliver the air volume specified according to unit size and/or job requirements. This is done with air volume bands in the blower wheels, with variable frequency drives, with electrically commutated motors, or with belt drive blowers. Field airflow adjustment is required at startup.

Electrically Commutated Motor (ECM) Air Adjustment

One blower option is ECM blowers. These blowers can read a 0-10V signal for modulating air flow or they can be operated at one speed using a potentiometer. Units ordered with controls by others will include the potentiometer wired to a terminal block so that either option can be used in the field.

If the application is for the motor to run at a constant speed, the potentiometer can be utilized without any change. If the application is to vary the motor speed for changing conditions, remove the jumper indicated on the terminal strip (red wire).

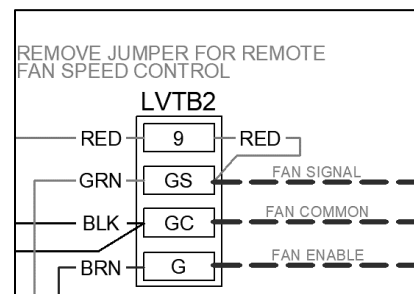

Figure 28 – Jumper for Remote Fan Speed Control

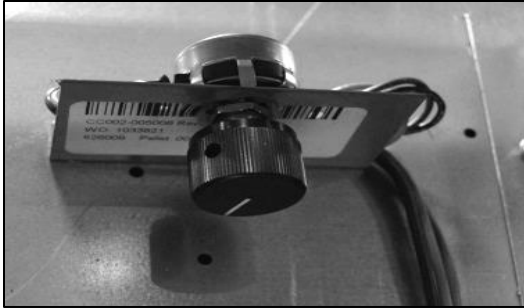

Figure 29 – Potentiometer

Note, the potentiometer is still active in the electrical loop. The potentiometer dial should be set for the maximum fan speed for a particular application. Maximum fan speed is determined by the ECat submittal. Typically, this max speed will be the rpm set at the factory.

The fan speed can be modulated using the 0-10 VDC input signal.

To check fan output from the factory, the potentiometer can be dialed to 100%. By sending a 5V signal*, for instance, the rpm can be measured and this reading can be converted to cubic feet of air moved by the fan.

It is advised that a medium range signal* be utilized for this procedure. The highest signal sent by the controller should then be determined by adjustment.

Banded Wheel Air Adjustment

In the event that reduced air volume is required, an air volume band can be installed within the blower wheel to reduce the amount of air delivery. If the unit is factory equipped with the air band but additional air delivery is needed, the band can be removed from the wheel.

The air band is sized according to the air delivery specifications and can be ordered from the factory for field installation.

The related photos of the wheel are provided for practical guidelines only in order to identify the air band location in the wheel. Actual field installation of the air band into the wheel will require access into and through the blower wheel venturi.

Air volume bands are made of aluminum, sized and equipped with easy bend tabs that are to be inserted into pre-punched slots provided on the wheel. Once the band has been inserted into the slots, it **MUST BE** secured by bending the tabs over from the back side of the wheel and also **MUST BE** secured from the inside by connecting the ends together with a pop-rivet in the holes provided on the ends of the band.

If the band is to be field installed, a hand held pop-rivet tool is recommended for connecting the band ends together. Caution must be taken to assure that the band is tightly installed and no damage, denting, or alteration to the wheel or blades occurs during the installation.

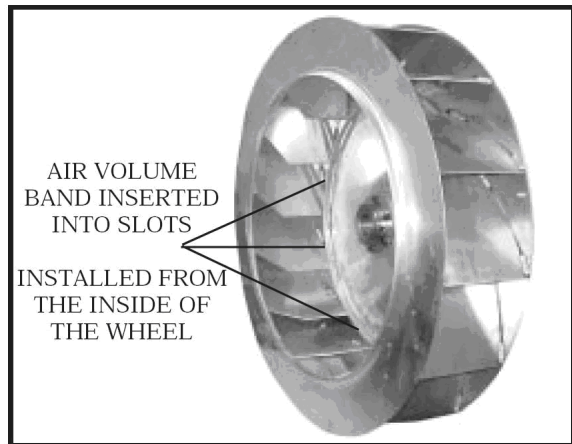
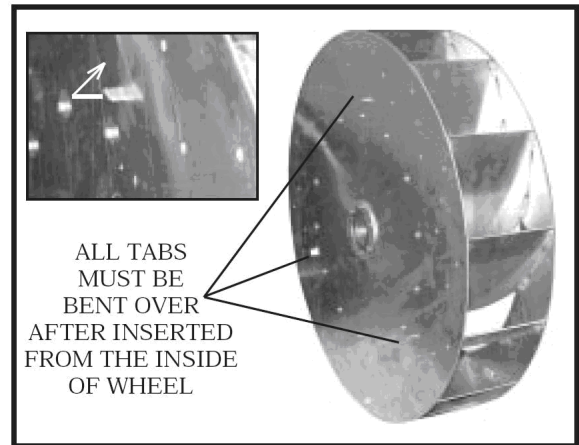
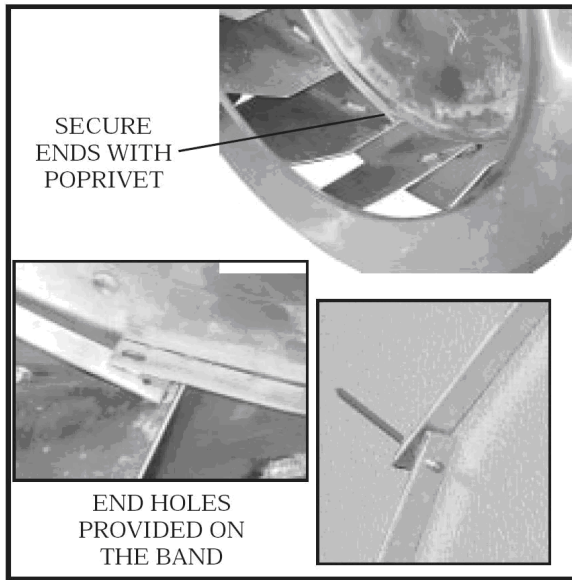

Figure 30 - Supply Fan Banding

Electric Heating

Heating is accomplished by passing electrical current through a specified amount of resistance heaters which will produce the required heat. The indoor fan motor will energize at the same time as the heaters. Wiring to the air handling unit must be done in accordance with local electrical codes and standards. Check specified electrical rating and install with proper wire size.

Electrical

Verify the unit name plate agrees with power supply. M2 Series units are provided with single point power wiring connections. Connection terminations are made to the main terminal block. A complete set of unit specific wiring diagrams, showing factory and field wiring are laminated in plastic and located inside the controls compartment door.

Table 10 - Nameplate Voltage Markings

Voltage Feature		Nameplate Voltage Marking	Min/Max VAC
1	230V/1Φ/60Hz	230	197/252
2	230V/3Φ/60Hz	230	197/252
3	460V/3Φ/60Hz	460	456/504
4	575V/3Φ/60Hz	575	570/630
8	208V/3Φ/60Hz	208	197/228
9	208V/1Φ/60Hz	208	197/228

WARNING

Disconnect all electrical power sources before servicing the unit. More than one power source may be provided. Failure to do so may result in injury or death from electrical shock or entanglement in moving parts.

All units require a field supplied electrical overcurrent and short circuit protection. Device must not be sized larger than the Maximum Overcurrent Protection (MOP) shown on the unit nameplate.

Codes may require a disconnect switch be within sight of the unit.

Note: Do not install the required field installed overcurrent protection or disconnect switch on the unit!

Electrical supply can enter through the bottom or side of the controls compartment. Entry must be field cut into panels of the unit.

A single point connection to a terminal block is provided. Split units may require connection between the units. High voltage conductors should enter the control panel in a separate opening and separate conduit than 24V low voltage conductors.

WARNING

The foam insulation releases dangerous fumes when it is burned. Do not cut a foam part with a cutting torch or plasma cutter. Do not weld to a foam filled part.

Note: Locations for field cut electrical entries are marked on the unit. Field cut openings must be a minimum of 15.25 cm (6 inches) away from all components and wiring to prevent damage due to drilling or cutting.

To pass wires through the wall or roof of the unit, a hole should be cut and conduit passed through it. Use the following procedure to cut a round hole in a foam panel.

Cutting Electrical Openings

1. Locate the placement of the hole. Be sure that the conduit will not interfere with the operation of any component or prevent access of any door or removable panel.
2. Drill a pilot hole all the way through the foam panel.
3. Using a hole saw cut the hole through the metal on both sides of the foam part.
4. With a knife cut the foam out of the hole.
5. After the conduit is installed in the hole caulk the entire perimeter of the hole on both sides with an industrial grade silicone sealant or a duct seal compound.

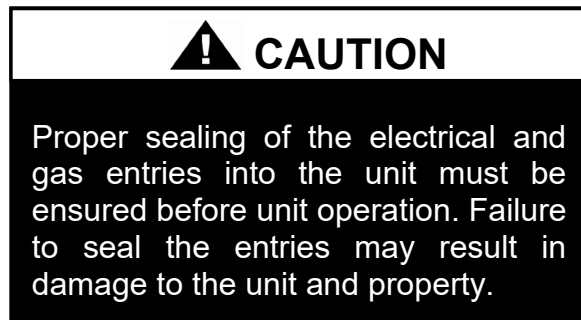

If a larger cut-out is needed for additional duct connections not provided by the factory, or for any other reason, it is very important that the foam be completely sealed. Insulation covers should be fabricated from sheet metal to cover the foam at the cut. The edges and corners that are not covered should be sealed using silicone caulking. If a reciprocating saw is used to make the cut out, take care that the metal skins of the foamed part do not separate from the foam, this would result in reduced structural integrity of the part.

Size supply conductors based on the unit Minimum Current Ampacity (MCA) rating.

Supply conductors must be rated a minimum of 75°C (167°F).

Protect the branch circuit in accordance with code requirements. The unit must be electrically grounded in accordance with local codes, or in the absence of local codes, the current National Electric Code, ANSI/NFPA 70 or the current Canadian Electrical Code CSA C22.1.

Wire power leads to the unit's terminal block or main disconnect. All wiring beyond this point has completed at the factory.

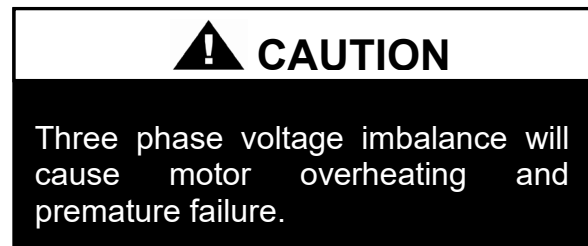

Supply voltage must be within the min/max range shown on the unit nameplate. Available short circuit current should not exceed the SCCR rating shown on the unit nameplate.

Three phase voltage imbalance will cause motor overheating and premature failure. The maximum allowable imbalance is 5%.

Voltage imbalance is defined as 100 times the maximum deviation from the average voltage divided by the average voltage.

Example:
 $(218V+237V+235V)/3 = 230V$, then
 $100*(230V-218V)/230V = 5.2\%$, which exceeds the allowable imbalance.

Check voltage imbalance at the unit disconnect switch and at the compressor terminal. Contact your local power company for line voltage corrections.

Installing contractor must check for proper motor rotation and check blower motor amperage listed on the motor nameplate is not exceeded. Motor overload protection may be a function of the variable frequency drive (VFD) and must not be bypassed.

Note: All units are factory wired for 208/230V, 460V, or 575V. If unit is to be connected to a 208V supply, the transformer must be rewired to 208V service. For 208V service interchange the yellow and red conductor on the low voltage control transformer.

Red-Black for 208V
Yellow-Black for 230V

 CAUTION
<p>Rotation must be checked on all MOTORS AND COMPRESSORS at startup by a qualified service technician. Scroll compressors are directional and can be damaged if rotated in the wrong direction. Compressor rotation must be checked using suction and discharge gauges. Fan motor rotation should be checked for proper operation. Alterations should only be made at the unit power connection</p>

Wire control signals to the unit's low voltage terminal block located in the controls compartment.

If any factory installed wiring must be replaced, use a minimum 105°C (221°F) type AWM insulated conductors.

Fuses and Circuit Breakers

The interrupting rating of fuses and circuit breakers is to be determined based on the KAIC rating of the unit. Refer to the wiring diagram for fuse sizing.

Table 11 – 35 KAIC Fuse Sizing

35 KAIC Construction		
Component	Description	Interrupting Rating (kA)
Fuse	Class CC, 600V, 0.5A - 30A	200
Fuse	Class J, 600V, 35A - 600A	200
Disconnect	3P, 600V, 15A - 600A	35

Table 12 – 65 KAIC Fuse Sizing

65 KAIC Construction		
Component	Description	Interrupting Rating (kA)
Fuse	Class CC, 600V, 0.5A - 30A	200
Fuse	Class J, 600V, 35A - 600A	200
Disconnect	3P, 600V, 15A - 600A	65

Thermostat Control Wiring

If a thermostat is used for unit control, thermostat should be located on an inside wall 1.2-1.5 meters (4-5 feet) above the floor where it will not be subjected to drafts, sun exposure, or heat from electrical fixtures of appliances. Control wiring must deliver adequate voltage to components to assure proper operation. Control voltage returning from controller circuit must be a minimum of 21 VAC. To assure proper wiring use the following chart to determine the allowable wiring distances.

Table 13 - Control Wiring

Wire Size (Stranded) - Copper Conductors Only	Total Wire Distance Allowable	
20 AWG	60.96 m	200 ft
18 AWG	106.7 m	350 ft
16 AWG	152.4 m	500 ft
14 AWG	228.6 m	750 ft
12 AWG	381.0 m	1250 ft

Total Wire Distance Allowable =
(Quantity of Control Wires) x
(Control Wire Distance)

Take the total wire distance allowable and divide by the number of wires to be connected. This indicates the distance allowable for that size wire. The wiring to the unit must not exceed the total wire distance allowable. If the voltage at the connectors is less than 21 VAC, isolation relays must be installed. If under external control 21 VAC must be field verified.

All external devices must be powered via a separate external power supply.

Example:

A total of 8 wires must be pulled 75ft to a control the unit. What size wire should be used?

According to the Table 2, 16 AWG allows for 63ft (500 ft/8 wires) and 14 AWG allows for 94ft (750 ft/8 wires). Thus, 14 AWG should be used.

Gas Fired Furnace

WARNING

Improper installation, adjustment, alteration, service, or maintenance can cause property damage, personal injury or loss of life. Startup and service must be performed by a Factory Trained Service Technician. A copy of this IOM should be kept with the unit.

Inspection on Arrival

1. Inspect unit upon arrival for any damage that may have occurred during shipping.
2. Prior to installation locate rating plate and verify that furnace is equipped for the available fuel supply and power supply at point of installation.

Unit Location and Clearances

1. Be sure unit is located with respect to building construction and other equipment to provide ready access and clearance to access panels or doors that must be opened to permit adjustment and servicing of the heating module.
2. The heating unit provided is listed for installation on the positive side of the circulating air blower only.
3. Locate unit to insure an adequate supply of fresh air to replace air used in the combustion and ventilation process.
4. When locating units, it is important to consider the exhaust vent piping connected to the outside atmosphere. Location should minimize the number of elbows or turns in vent pipe.
5. Do not install unit where it may be exposed to potentially explosive or flammable vapors.

- Do not locate unit in areas where corrosive vapors (such as chlorinated, halogenated, or acidic) are present in the atmosphere or can be mixed with combustion air entering heater.

Gas Supply, Piping and Connections

Gas piping must be installed in accordance with local codes, or in the absence of local code, installation must conform to the current (United States) National Fuel Gas Code ANSI-Z223.1/NFPA 54 or the current (Canada) National Fuel & Propane Installation Code CSA B149.1 or B149.2.

- Gas piping must be sized for the total Btu input of all units (heaters) serviced by a single supply. Individual heat module gas supply pipe connection size is 19 mm (¾”) NPT for gas inputs up to 400 MBH & 1”NPT for 401-600 MBH.
- Ensure that gas regulators servicing more than one heater have the proper pipe and internal orifice size for the total input of all heaters serviced by the regulator.
- Natural Gas furnaces require a **minimum** inlet gas pressure of 9.34 mmHg (**5.0” w.c.**) and limited to a **maximum** inlet gas pressure of 25.2 mmHg (**13.5” w.c.**) with the furnace operating.

Table 15 – Gas Inlet Pressures (Imperial)

Gas Inlet Pressures (“wc)	Natural Gas	Propane Gas (LP)
Minimum (50-400 MBH)	5.0”wc	11.0”wc
Minimum (400-600 MBH)	6.0”wc	12.0”wc
Maximum	13.5”wc	13.5”wc

Table 14 – Gas Inlet Pressure (Metric)

Gas Inlet Pressures (mmHg)	Natural Gas (mmHg)	Propane Gas (LP) (mmHg)
Minimum (50-400 MBH)	9.34	20.55
Minimum (400-600 MBH)	11.21	22.42
Maximum	25.22	25.22

4. A 3.2mm (1/8") NPT tap is provided on the inlet side of the gas valve to the heater. A fitting suitable for connection to a pressure gauge capable of measuring gas pressure should be connected to each heater serviced by a single regulator so that gas pressure at each heater can be measured with all heaters in operation.
5. A drip leg (sediment trap) and a manual shut off valve must be provided immediately upstream of the gas control on the heating unit. To facilitate servicing of unit, installation of a union is recommended.
6. All gas supply and heater connections must be leak tested prior to placing equipment in service.

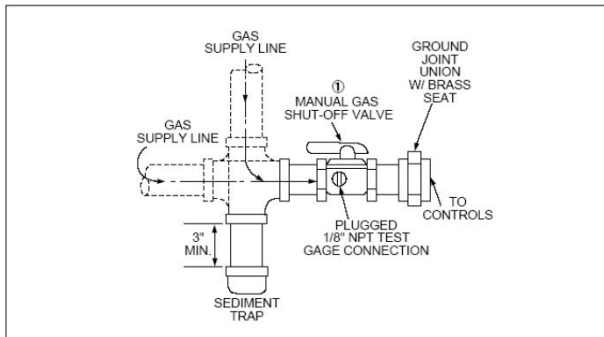

Figure 31 - Sediment Trap for Gas Heat

! WARNING

1. All field gas piping must be pressure/ leak tested prior to operation. NEVER use an open flame to check for leaks. Use a soap solution or other leak detecting solution for testing.

2. Gas pressure to appliance controls must never exceed 13.5" w.c. (1/2 psi)

! WARNING

1. When pressure testing at 13.5" w.c. (1/2 psi) or less, close the manual shutoff valve on the appliance before testing.

2. When pressure testing gas supply line at 13.5" w.c. (1/2 psi) or higher, close manual gas valve and disconnect heater from supply line to be tested. Cap or plug the supply line.

Gas Furnace Component Identification

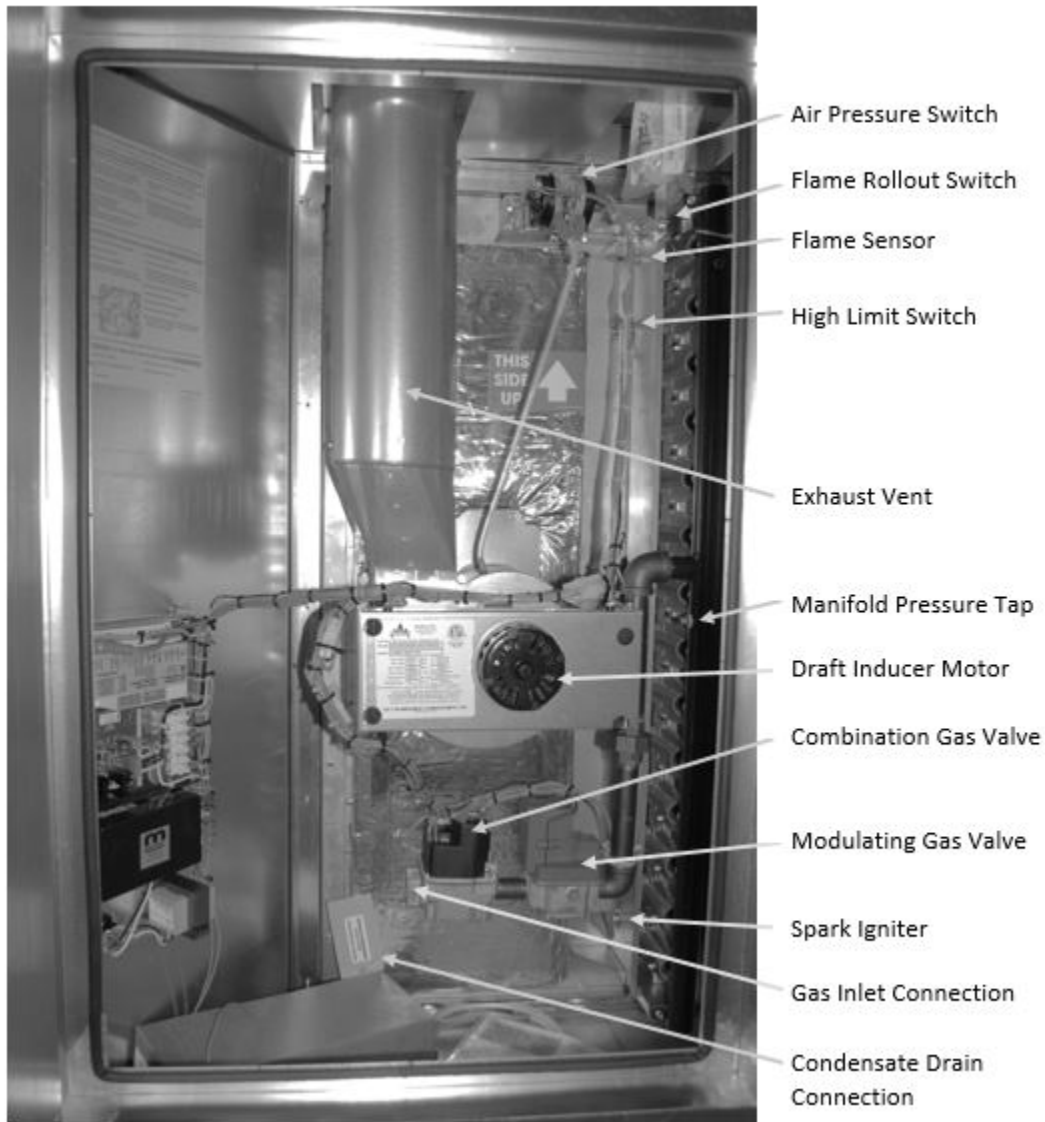

Figure 32 – Gas Heater Component Identification

Horizontal Airflow Configuration

1. Airflow may be from either right or left for heater as shown, without any difference in system performance.
2. In applications with modulating controls, temperature rises below 4.4°C (40°F), or with outside air make-up air, some condensation may occur in the heating cycle. Flue gas condensate is corrosive and will result in shortened heat exchanger life. In these

- applications, connection of a condensate drain line is required to avoid condensate buildup and possible heat exchanger damage. If condensate drain lines are run through unheated spaces, apply heat tape to prevent condensate from freezing.
3. If heating section is located downstream of a refrigeration system or cooling coil, condensation can occur during operation of the air conditioning,

resulting in condensation from warm, moist air in the heat exchanger tubes and flue collector. This condensate is not harmful to the heat exchanger provided it is drained continuously. For these applications a .64 cm (1/4 inch) NPT connection is provided for attachment of condensate drain line to remove condensate from heat exchanger.

4. Disposal of condensate is subject to local codes and ordinances. Some municipalities require that the acidic condensate produced be neutralized before being discharged into the sanitary sewer. If a condensate neutralizer kit is field installed, it must be installed where it can be easily accessed for inspection and maintenance.

General Venting

Safe operation of indirect-fired gas furnaces requires a properly operating vent system which exhausts all the products of combustion (flue gases) to the outside atmosphere.

Venting must be in accordance with local codes and the National Fuel Gas Code NFPA54 / ANSI Z223.1 in the United States or CSA B149.1 Natural and Propane Installation Code in Canada. Local requirements typically supersede national requirements.

 WARNING
FURNACE VENTING
<p>Failure to provide proper venting affects furnace performance and may result in a health hazard which could cause serious personal injury or death.</p>

A collar is provided on each furnace for attachment of vent piping as listed

Table 16 – Vent Pipe Connection Size

Input Rating (MBH)	For Vent Pipe Diameter
75.0 – 149.9 MBH	12.7cm (5")
150.0 – 400.0 MBH	15.25cm (6")
401.0 – 600.0 MBH	17.8 cm (7")

Vertically Vented

1. Refer to Table 13.1 (a) in ANSI Z223.1 or Table C.1 in CSA B149.1 for vent pipe sizing. HD furnaces are fan-assisted. Use "FAN" column for maximum and minimum input base on vertical and lateral vent pipe runs.
2. Maximum vent lengths are based on total equivalent length of pipe which must include fittings and elbows. Equivalent length of 12.7 or 17.8 cm (5 or 6 inch) elbows is 1.5 m (5 ft), and for a 17.8 cm (7 inch) elbow is 2.1 m (7 feet).
3. The top of the vent pipe must extend at least two .6 (2) meters (feet) above the highest point on the roof.
4. Horizontal runs should be pitched upward .64 cm (1/4") per foot and should be supported at .9 m (3 foot) maximum intervals.
5. Install a tee fitting at the low point of the vertical section with a drip leg and cleanout cap.
6. Vent must terminate in a Listed, weatherproof vent cap.
7. Vent connectors serving Category 1 heaters must not be connected into any portion of a mechanical draft system operating under positive pressure. Dampers must not be used in vent piping runs. Spillage of flue gases into the occupied space could result.

Horizontally Vented

Vent pressures in horizontally vented furnaces are positive and therefore are classified as Category III venting systems in accordance with ANSI standards. All vent pipe joints must be sealed to prevent leakage of flue gases into the heated space.

Use only Category III vent materials listed to UL1738 / ULC S636 for vent pipe and fittings.

All field installed vent pipe and fittings must be from the same manufacturer. DO NOT intermix vent system parts from different vent manufacturers. Follow instruction provided with approved venting materials used.

Seal joint at connection to flue collar with a high temperature silicone sealant with temperature rating of 260°C (500°F).

The total equivalent length of vent pipe must not exceed 15.2 m (50 ft). Equivalent length of 12.7 or 17.8 cm (5 or 6 inch) 90° elbows is 1.5 m (5 ft), and for a 17.8 cm (7 inch) 90° elbow is 2.1 m (7 feet). 45° Elbows are half of the equivalent length of 90°.

The vent system must also be installed to prevent collection of condensate. Pitch horizontal pipe runs downward .64 cm (¼ in.) per foot toward the outlet to permit condensate drainage. Maintain 6 in. clearance between vent pipe and combustible materials.

EACH DUCT FURNACE MUST HAVE ITS OWN INDIVIDUAL VENT PIPE AND TERMINAL. Do not connect vent system from horizontally vented units to other vent systems or a chimney.

1. A Tee Fitting termination or Vent Cap listed for horizontal venting must be provided.

2. Termination fitting inlet diameter must be same as the required vent pipe diameter. The vent terminal must be at least 30.5 cm (12 in.) from any exterior wall to prevent degradation of building material by flue gases.
3. The vent terminal must be located at least 0.9 m (3 ft) above grade, or in snow areas, above snow line to prevent blockage. Additionally, the vent terminal must be installed with a minimum horizontal clearance of 1.2 m (4 ft) from electric meters, gas meters, regulators or relief equipment.
4. Through the wall vents shall not terminate over public walkways, or over an area where condensate or vapor could create a nuisance or hazard.

Two-Pipe Separated Combustion Venting

The furnace must be mounted with the burner section in a reasonably airtight vestibule compartment, as these systems provide combustion air from outside the heated space and vent the products of combustion outdoors. Additionally the heating unit must include the following:

1. For vent pipe and fittings conveying flue gases, use only Category III vent materials listed to UL1738 / ULC S636 from same vent manufacturer. DO NOT intermix vent system parts from different vent manufacturers. Follow instruction provided with approved venting materials used.
2. For combustion air piping, use of 24 gauge galvanized steel single wall pipe is acceptable. Tape joints with aluminum foil tape and secure with corrosion resistant screws.
3. Inlet air pipe must be same size as exhaust vent pipe based on input ratings.

4. Exhaust and vent piping must not exceed a combined 50 equivalent feet in length.
5. See Figure 36 and Figure 37 for recommend vent terminations and air inlet fittings for venting configuration. Proper installation of air inlet and flue gas exhaust piping are essential to proper operation of the heat module. NOTE: The inlet and outlet terminals must be located in the same pressure zone to provide for safe appliance operation.

Separated combustion systems may not be common vented. Each heater must have its own individual air supply and flue gas exhaust vent.

If vent system application does not meet the criteria outlined in the diagrams and information provided, contact a manufacturer of venting systems and materials for assistance with system design.

If vent cap terminations are used, be sure that the vent cap used is approved for horizontal application. Certain vent terminals are approved for vertical installation only.

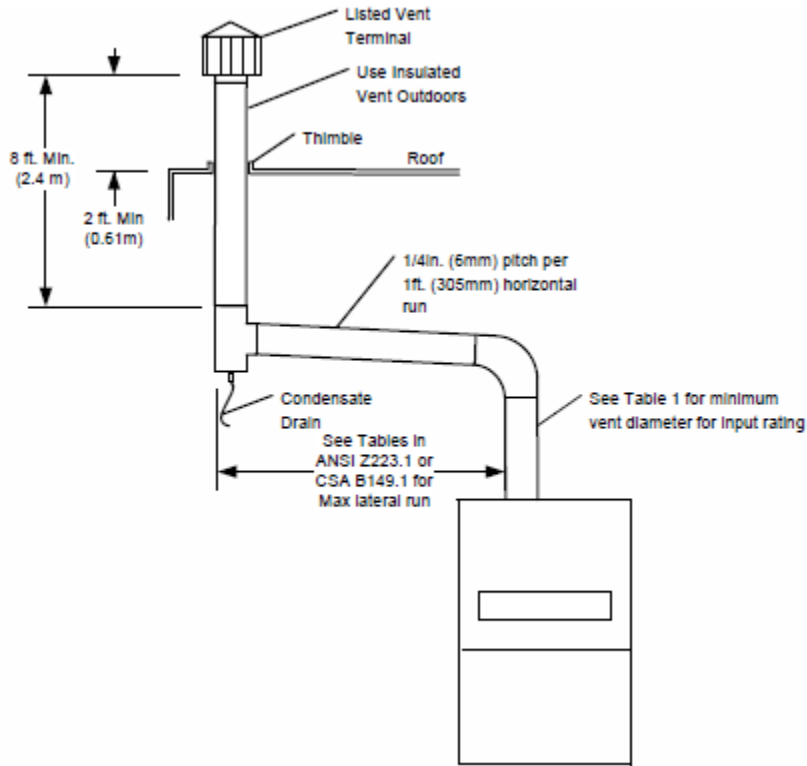

Figure 33 – Indoor Vertical Venting (Category I)

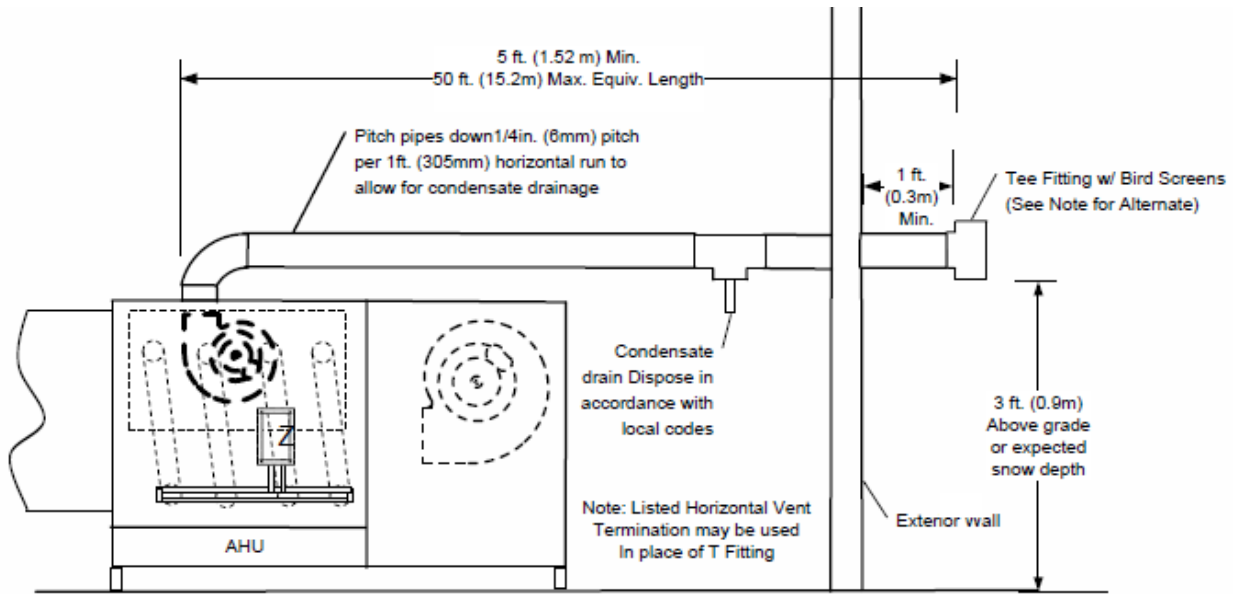

Figure 34 – Indoor Horizontal Venting (Category III)

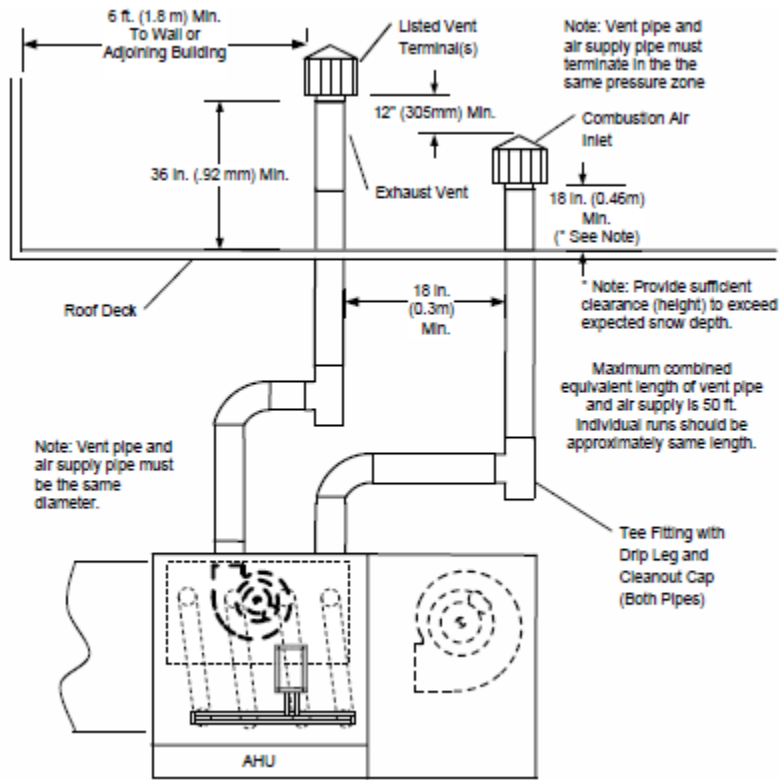

Figure 35 – Indoor Vertical Venting Separated Combustion

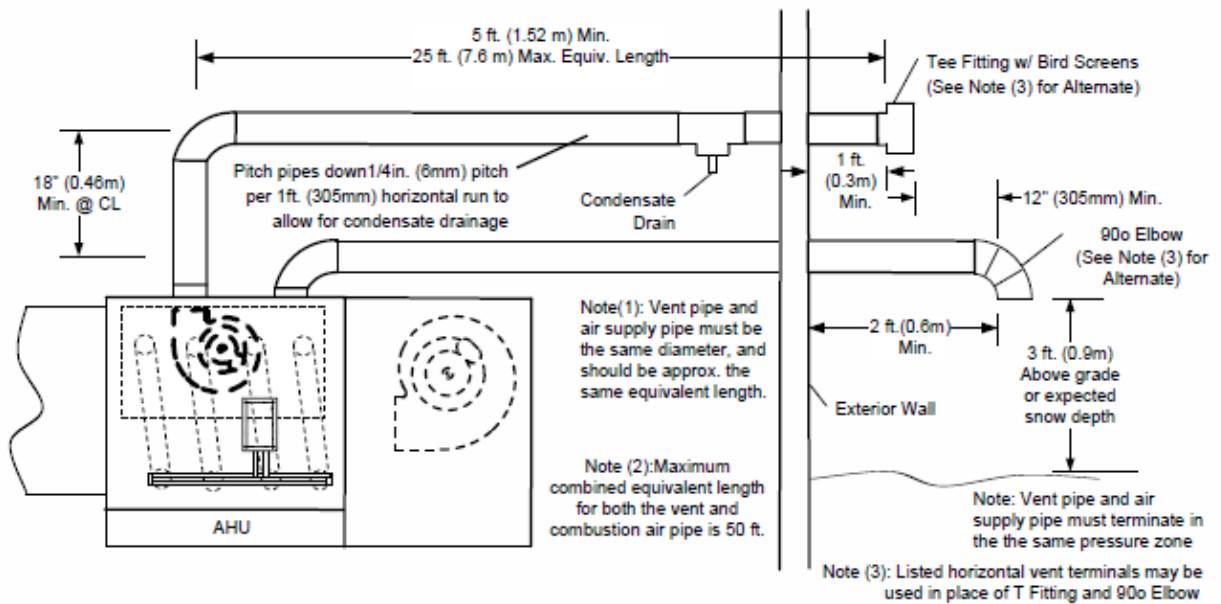

Figure 36 – Indoor Horizontal Venting Separated Combustion

Energy Recovery Units

AAONAIRE® units have been equipped with an energy recovery wheel. This section is provided to assure the energy recovery feature will be properly setup to perform in accordance with the job specifications for your particular application.

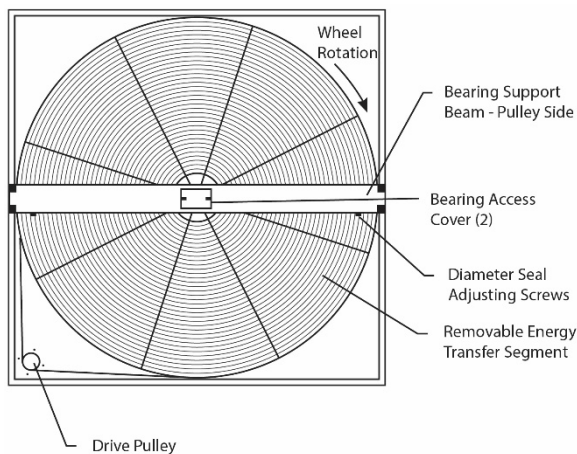

Figure 37 - Energy Recovery Wheel

The Energy Recovery Cassette consists of a frame wheel, wheel drive system, and energy transfer segments. Segments are removable for cleaning or replacement. The segments rotate through counter flowing exhaust and outdoor air supply streams where they transfer heat and/or water vapor from the warm, moist air stream to the cooler and/or drier air stream.

The initial setup and servicing of the energy recovery wheel is very important to maintain proper operation efficiency and building occupant comfort.

Normal maintenance requires periodic inspection of filters, the cassette wheel, drive belts, air seals, wheel drive motor, and its electrical connections.

Wiring diagrams are provided with each motor. When wired according to wiring diagram, motor rotates clockwise when viewed from the shaft/pulley side.

By carefully reviewing the information within this section and following the instructions, the risk of improper operation and/or component damage will be minimized.

It is important that periodic maintenance be performed to help assure trouble free operation.

Initial Mechanical Check and Setup

Outdoor air intake adjustments should be made according to building ventilation, or local code requirements.

After the unit installation is complete, open the cassette access door and determine that the energy wheel rotates freely when turned by hand. Apply power and observe that the wheel rotates at approximately 30 RPM. If the wheel does not rotate when power is applied, it may be necessary to readjust the “diameter air seals”.

Air Seal Adjustments

Pile type air seals across both sides of the energy wheel diameter are factory adjusted to provide close clearance between the air seal and wheel. Racking of the unit or cassette during installation, and/or mounting of the unit on a non-level support or in other than the factory orientation can change seal clearances. Tight seals will prevent rotation.

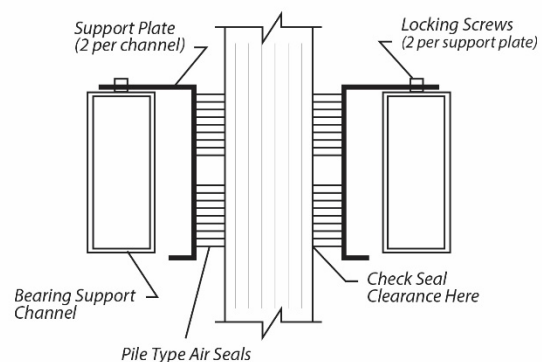

Figure 38 - Cross Section of Air Seal Structure

Wheel to Air Seal Clearance

To check wheel to seal clearance; first disconnect power to the unit, in some units the energy recovery wheel assembly can be pulled out from the cabinet to view the air seals. On larger units, the energy recovery wheel may be accessible inside the walk-in cabinet.

A business card or two pieces of paper can be used as a feeler gauge, (typically each .1mm (.004”) thick) by placing it between the face of the wheel and pile seal.

Using the paper, determine if a loose slip fit exist between the pile seal and wheel when the wheel is rotated by hand.

To adjust air seal clearance, loosen all seal plate retaining screws holding the separate seal retaining plates to the bearing support channels and slide the seals plates away from the wheel. Using the paper feeler gauge, readjust and retighten one seal plate at a time to provide slip fit clearance when the wheel is rotated by hand.

Confirm that the wheel rotates freely. Apply power to the unit and confirm rotation.

Airflow Balancing and Checking

High performance systems commonly have complex air distribution and fan systems. Unqualified personnel should not attempt to adjust fan operation, or air circulation, as all systems have unique operations characteristics. Professional air balance specialists should be employed to establish actual operating conditions, and to configure the air delivery system for optimal performance.

Controls

A variety of controls and electrical accessories may be provided with the equipment. Identify the controls on each unit

by consulting appropriate submittal, or order documents, and operate according to the control manufacturer’s instructions. If you cannot locate installation, operation, or maintenance information for the specific controls, then contact your sales representative, or the control manufacturer for assistance.

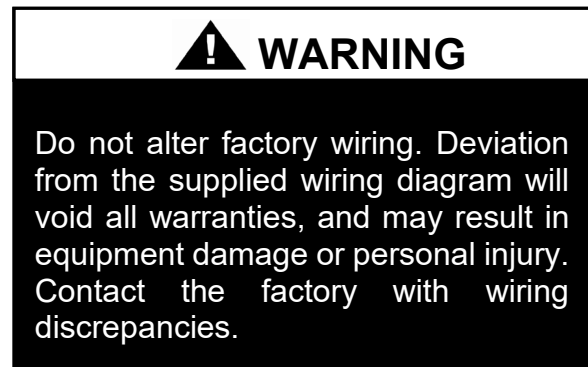

Routine Maintenance and Handling

Handle cassettes with care. All cassettes should be lifted by the bearing support beam. Holes are provided on both sides of the bearing support beams to facilitate rigging as shown in the following illustration.

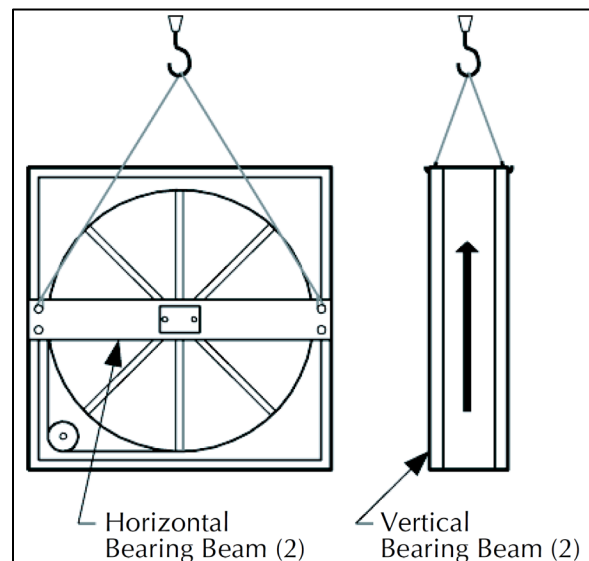

Figure 39 - Lifting Hole Locations

Routine maintenance of the Energy Recovery Cassettes includes periodic cleaning of the

Energy Recovery Wheel as well as inspection of the Air Seals and Wheel Drive Components as follows:

Cleaning

The need for periodic cleaning of the energy recovery wheel will be a function of operating schedule, climate and contaminants in the indoor air being exhausted and the outdoor air being supplied to the building.

The energy recovery wheel is “self-cleaning” with respect to dry particles due to its laminar flow characteristics. Smaller particles pass through; larger particles land on the surface and are blown clear as the flow direction is reversed. Any material that builds up on the face of the wheel can be removed with a brush or vacuum. The primary need for cleaning is to remove oil based aerosols that have condensed on energy transfer surfaces. A characteristic of all dry desiccants, such as silica gel, is that they can form films that close off micron sized pores at the surface of the desiccant material, reducing the efficiency by which the desiccant can adsorb and desorb moisture and also build up so as to reduce airflow.

In a reasonably clean indoor environment such as a school or office building, measurable reductions of airflow or loss of sensible (temperature) effectiveness may not occur for several years. Measurable changes in latent energy (water vapor) transfer can occur in shorter periods of time in applications such as moderate occupant smoking or cooking facilities. In applications experiencing unusually high levels of occupant smoking or oil based aerosols such as industrial applications involving the ventilation of machine shop areas for example, annual washing of energy transfer may be necessary to maintain latent transfer efficiency. Proper cleaning of the energy recovery wheel will restore latent effectiveness to near original performance.

To clean, gain access to the energy recovery wheel and remove segments. Brush foreign material from the face of the wheel. Wash the segments or small wheels in a 5% solution of non-acid based coil cleaner or alkaline detergent and warm water.

Soak in the solution until grease and tar deposits are loosened (Note: some staining of the desiccant may remain and is not harmful to performance). Before removing, rapidly run finger across surface of segment to separate polymer strips for better cleaning action. Rinse dirty solution from segment and remove excess water before reinstalling in wheel.

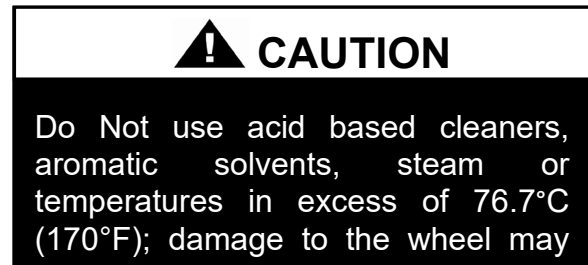

Air Seals

Four adjustable diameter seals are provided on each cassette to minimize transfer of air between the counter flowing airstreams.

To adjust diameter seals, loosen diameter seal adjusting screws and back seals away from wheel surface. Rotate wheel clockwise until two opposing spokes are hidden behind the bearing support beam. Using a folded piece of paper as a feeler gauge, position paper between the wheel surface and diameter seals.

Adjust seals towards wheel surface until a slight friction on the feeler gauge (paper) is detected when gauge is moved along the length of the spoke. Retighten adjusting screws and recheck clearance with “feeler” gauge.

Wheel Drive Components

The wheel drive motor bearings are pre-lubricated and no further lubrication is necessary.

The wheel drive pulley is secured to the drive motor shaft by a combination of either a key or D slot and set screw.

The set screw is secured with removable locktite to prevent loosening. Annually confirm set screw is secure. The wheel drive belt is a urethane stretch belt designed to provide constant tension through the life of the belt. No adjustment is required. Inspect the drive belt annually for proper tracking and tension. A properly tensioned belt will turn the wheel immediately after power is applied with no visible slippage during start-up.

Installation Considerations

Energy recovery cassettes are incorporated within the design of packaged units, packaged air handlers and energy recovery ventilators. In each case, it is recommended that the following considerations be addressed:

Accessibility

The cassette and all its operative parts; i.e.: motor, belt, pulley, bearings, seals and energy transfer segments must be accessible for service and maintenance. This design requires that adequate clearance be provided outside the enclosure.

Orientation & Support

The Energy Recovery Cassette may be mounted in any orientation. However, Care must be taken to make certain that the cassette frame remains flat and the bearing beams are not racked.

To verify, make certain that the distance between wheel rim and bearing beam is the

same at each end of the bearing beam, to within .64 cm (1/4 of an inch) (dimension A & B). This amount of racking can be compensated for by adjusting the diameter seals.

If greater than .64 cm (1/4 inch) (dimension C), racking must be corrected to ensure that drive belt will not disengage from wheel.

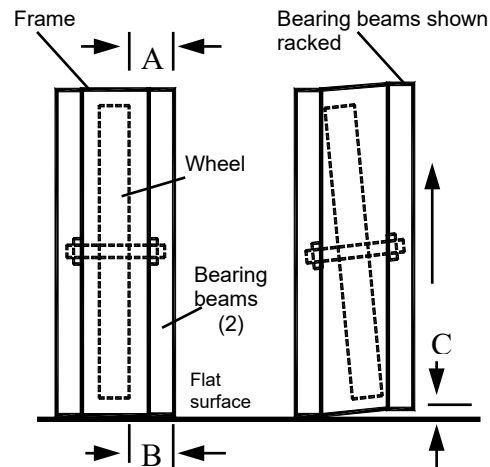

Figure 40 - Avoid Racking of Cassette Frame

Operation

**CAUTION**

Keep hands away from rotating wheel!
Contact with rotating wheel can cause physical injury.

Startup Procedure

1. By hand, turn wheel clockwise (as viewed from the pulley side), to verify wheel turns freely through 360° rotation.
2. Before applying power to drive motor, confirm wheel segments are fully engaged in wheel frame and segment retainers are completely fastened. (See Segment Installation Diagram).

3. With hands and objects away from moving parts, activate unit and confirm wheel rotation. Wheel rotates clockwise (as viewed from the pulley side).
4. If wheel has difficulty starting, turn power off and inspect for excessive interference between the wheel surface and each of the four (4) diameter seals. To correct, loosen diameter seal adjusting screws and back adjustable diameter seals away from surface of wheel, apply power to confirm wheel is free to rotate, then re-adjust and tighten hub and diameter seals, as shown in hub seal adjustment diagram.
5. Start and stop wheel several times to confirm seal adjustment and to confirm belt is tracking properly on wheel rim (approximately .64 cm (1/4") from outer edge of rim).

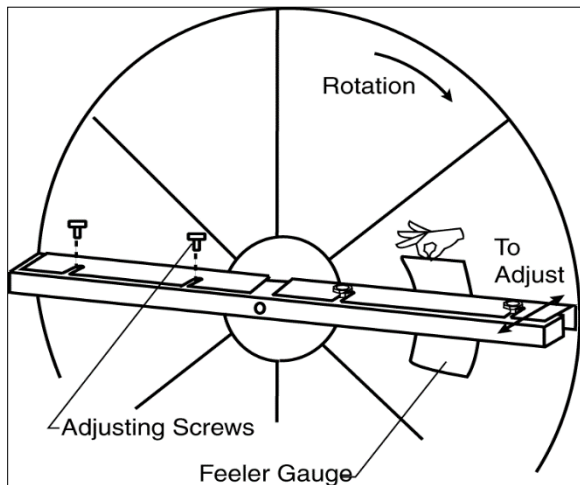

Figure 41 - Diameter Seal Adjustment

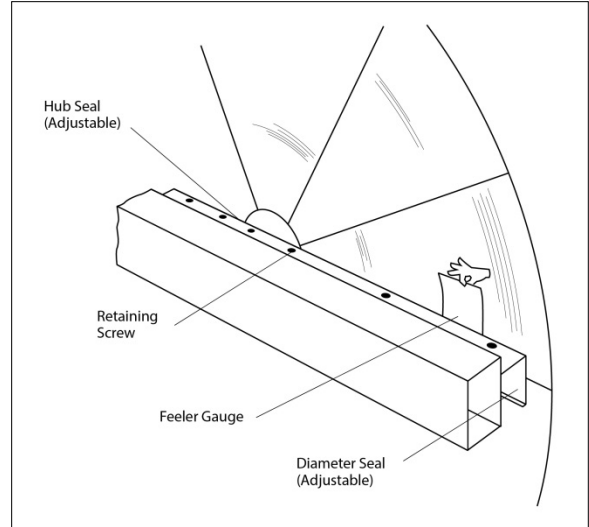

Figure 42 - Hub Seal Adjustment

Service

! CAUTION

Disconnect electrical power before servicing energy recovery cassette. Always keep hands away from bearing support beam when installing or removing segments. Failure to do so could result in severe injury to fingers or hand.

Segment Installation & Replacement

Wheel segments are secured to the wheel frame by a Segment Retainer which pivots on the wheel rim and is held in place by a Segment Retaining Catch.

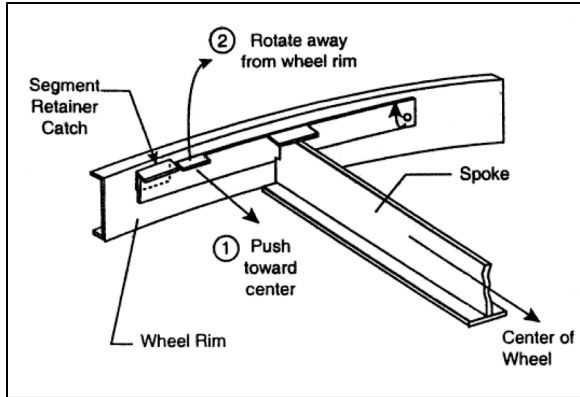

Figure 43 - Segment Retainer

To install wheel segments follow steps one through five below. Reverse procedure for segment removal.

1. Unlock two segment retainers (one on each side of the selected segment opening).
2. With the embedded stiffener facing the motor side, insert the nose of the segment between the hub plates.

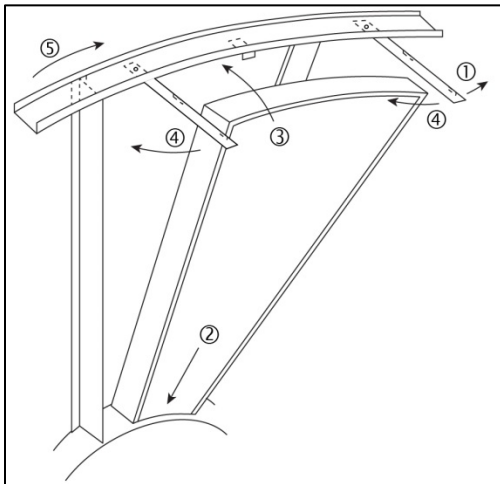

Figure 44 - Segment Installation

3. Holding segment by the two outer corners, press the segment towards the center of the wheel and inwards against the spoke flanges. If hand pressure does not fully seat the segment, insert the flat tip of a screw driver between the wheel rim and outer corners of the segment

and apply downward force while guiding the segment into place.

4. Close and latch each Segment Retainer under Segment Retaining Catch.
5. Slowly rotate the wheel 180°. Install the second segment opposite the first for counterbalance. Rotate the two installed segments 90° to balance the wheel while the third segment is installed. Rotate the wheel 180° again to install the fourth segment opposite the third. Repeat this sequence with the remaining four segments.

Wheel Drive Motor and Pulley Replacement

1. Disconnect power to wheel drive motor.
2. Remove belt from pulley and position temporarily around wheel rim.
3. Loosen set screw in wheel drive pulley using a hex head wrench and remove pulley from motor drive shaft.
4. While supporting weight of drive motor in one hand, loosen and remove (4) mounting bolts.
5. Install replacement motor with hardware kit supplied.
6. Install pulley to dimension as shown and secure set screw to drive shaft.
7. Stretch belt over pulley and engage in groove.
8. Follow start-up procedure.

Belt Replacement

1. Obtain access to the pulley side bearing access plate if bearing access plates are provided. Remove two bearing access plate retaining screws and the access plate.
2. Using hexagonal wrench, loosen set screw in bearing locking collar. Using light hammer and drift (in drift pin hole) tap collar in the direction of wheel rotation to unlock collar. Remove collar.

3. Using socket wrench with extension, remove two nuts which secure bearing housing to the bearing support beam. Slide bearing from shaft. If not removable by hand, use bearing puller.
4. Form a small loop of belt and pass it through the hole in the bearing support beam. Grasp the belt at the wheel hub and pull the entire belt down.

Note: Slight hand pressure against wheel rim will lift weight of wheel from inner race of bearing to assist bearing removal and installation.

CAUTION

Protect hands and belt from possible sharp edges of hole in Bearing Support Beam.

10. Lock in position by tapping drift pin with hammer and drift. Secure in position by tightening set screw.
11. Reinstall Bearing Access Cover.
12. Apply power to wheel and ensure that the wheel rotates freely without interference.

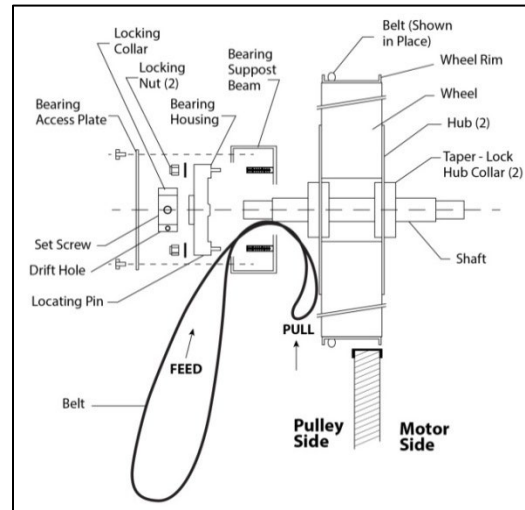



Figure 45 - Belt Replacement

5. Loop the trailing end of the belt over the shaft (belt is partially through the opening).
6. Reinstall the bearing onto the wheel shaft, being careful to engage the two locating pins into the holes in the bearing support beam. Secure the bearing with two self-locking nuts.
7. Install the belts around the wheel and pulley according to the instructions provided with the belt.
8. Reinstall diameter seals or hub seal and tighten retaining screws. Rotate wheel in clockwise direction to determine that wheel rotates freely with slight drag on seals.
9. Reinstall bearing locking collar. Rotate collar by hand in the direction the wheel rotates (see label provided on each cassette for wheel rotation).

Startup

(See back of the manual for startup form)

WARNING

Improper installation, adjustment, alteration, service or maintenance can cause property damage, personal injury or loss of life. Installation and service must be performed by a trained, qualified installer. A copy of this IOM should be kept with the unit.

WARNING

Electric shock hazard. Shut off all electrical power to the unit to avoid shock hazard or injury from rotating parts.

During startup, it is necessary to perform routine checks on the performance of the unit. This includes checking of the air flow, the air filters, condenser water flow and refrigerant charge.

Filters

Do not operate the unit without filters in place. Operation of the equipment without filters in place can result in clogged coils. Units are shipped with the selected filters installed. If filters have been removed during installation, open the filter access door and re-install the correct filters with the airflow indicator arrows pointing in the direction of airflow.

Filters should be checked after a few days of operation after the unit has been started up as dust and debris from construction may cause premature filter loading. Replace the filters if necessary.

Check Out

Equipment should be thoroughly checked for loose wiring, a free spinning blower wheel, and well-fitting access panels. Air handlers should not be operated without proper ductwork and access panels installed, except as required during start-up and air balancing.

1. Check all electrical connections to be sure they are tight.
2. Open all access panels, and remove all shipping screws, or restraints.
3. Clean out any debris that may have been left.
4. Check belt alignment and tightness of fan drives.
5. Check bearing locking collars and fan wheel set screws for tightness.
6. Turn fan wheels to assure free rotation.
7. Ensure electrical supply matches the unit nameplate.

8. Ensure condensate lines are connected, glued, and sloped toward building drain.
9. Check local codes for any special provisions.
10. Attach or close all access doors and panels.
11. Ensure that all ductwork dampers are open.
12. Check electrical phasing to ensure the fan rotates in the proper direction.

Electric Heating Section Procedures:

1. Perform final visual inspection. Check all equipment, ductwork, and piping to verify that all work is complete and equipment is properly installed and mounted. Improperly installed equipment or ductwork can affect readings.
2. Ensure there is no construction debris in the unit.
3. Check the unit for external damage.
4. Note all accessories installed.
5. Install new filters of the proper size and type.
6. Check all terminal blocks, fuses, fuse blocks, and contactors for correctness.
7. Check all high and low voltage wiring connections for correctness and tightness.
8. Check unit for correct incoming voltage per the data plate.
9. Check the security of the locking system on all blower bearings
10. Turn the unit power on.
11. Turn the unit blower on and check for correct rotation.
12. If correct, take blower amp readings and compare to see if the amp draw is within the safety factor area of the motor. Once correct, turn blower off.
13. Turn on the first stage of heating
 - Check amp draw of each element of each stage
 - Ensure blower started w/ electric heat

- Check for temperature rise across heating section while all stages are on
- If temperature rise is within range, turn all heating calls off
- Check to see that blower stops

Refrigerant (DX) Cooling Section Procedures:

1. Perform final visual inspection. Check all equipment, ductwork, and piping to verify that all work is complete, and equipment is properly installed and mounted. Improperly installed equipment, or ductwork can affect readings.
2. Perform condenser start-up checks in addition to these air handler checks according to the condenser manufacturer's instructions.
3. Ensure there is no construction debris in the unit.
4. Check the unit for external damage.
5. Note all accessories installed.
6. Ensure that drain P-trap is properly installed.
7. Check all terminal blocks, fuses, fuse blocks, and contactors for correctness.
8. Check all high and low voltage wiring connections for tightness. Check unit for correct incoming voltage per the data plate.
9. Check the security of the locking system on all blower bearings
10. Turn the unit power on.
11. Turn the unit blower on and check for correct rotation.
12. If correct, take blower amp readings and compare to see if the amp draw is within the safety factor area of the motor.
13. Check and record ambient temperature.
14. Check for Guaranteed Off Timers (GOT) and Time Delay Relays (TDR).
15. Start the first stage cooling circuit and blower circuit.

16. After all stages of cooling have been on for at least five minutes, record the return air temperature and supply air temperature.
17. Check the temperature difference across the evaporator coil.

Gas Heater

Operating and Safety Instructions

1. This gas furnace does not have a pilot. It is equipped with a direct spark ignition device that automatically lights the gas burner. DO NOT try to light burners by hand.
2. BEFORE OPERATING, leak test all gas piping up to heater gas valve. Smell around the unit area for gas. DO NOT attempt to place heater in operation until source of gas leak is identified and corrected.
3. Use only hand force to push and turn the gas control knob to the "ON" position. NEVER use tools. If knob does not operate by hand, replace gas valve prior to starting the unit. Forcing or attempting to repair the gas valve may result in fire or explosion.
4. Do not attempt to operate unit if there is indication that any part or control has been under water. Any control or component that has been under water must be replaced prior to trying to start the unit.

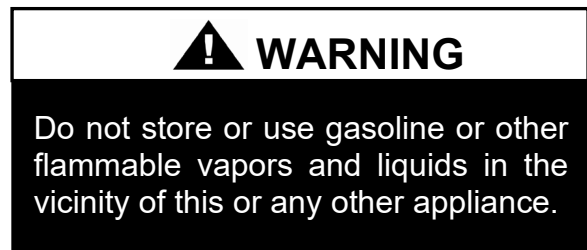

Gas Heater Start-up

1. Turn thermostat or temperature controller to its lowest setting.
2. Turn off gas supply at the manual shut-off valve (supplied by others).

3. Turn off power to the unit at the disconnect switch.
4. Open door to unit module housing the gas heater.
5. Move gas control knob to “OFF” position.
6. Install a tapped fitting for attachment to a manometer or other gauge suitable for 26.2 mmHg (14.0” w.c.) in the inlet pressure tap, and for 18.7 mmHg (10.0” w.c.) in the manifold pressure tap.
7. Wait 5 minutes for any gas to clear out. If you smell gas, turn off gas supply at the manual shut-off valve (field installed). If you don’t smell gas or have corrected any leaks, go to the next step.
8. Turn gas control knob to “ON” position.
9. Open all manual gas valves (supplied by others).
10. Turn power on at disconnect switch.
11. Set thermostat or controller to its highest position to initiate call for heat and maintain operation of unit.
12. Draft inducer will run for a 15 to 30 second pre-purge period.
13. At the end of the pre-purge the direct spark will be energized and gas valve will open.
14. Burners ignite.

Gas Valves

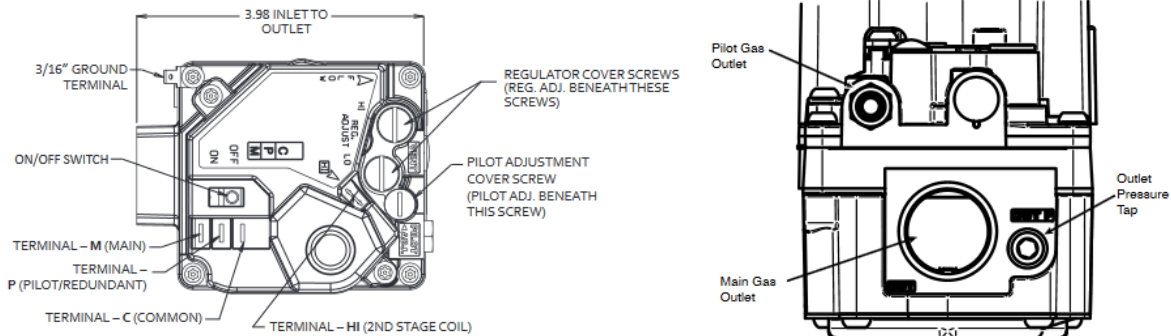

Figure 46 – Combination Gas Valve

Inlet Gas Pressure

Verify inlet (line) gas pressure to the combination valve provided. A 3.2 mm (1/8”) NPT tapping is provided on the gas valve for measuring inlet pressure.

Input

The correct heat capacity of the furnace is controlled by the burner orifices and the gas manifold pressure. The manifold pressure is factory set but should be checked at the time of start-up.

Manifold Pressure Adjustment

A pressure tap is provided in each furnace for measuring the gas manifold pressure. Manifold pressure must be checked at start-up and during any service or maintenance. All control systems operate at a manifold pressure of 6.35 to 6.5 (3.4 to 3.5) mmHg (inwc) at maximum input on natural gas, and 18.7 mmHg (10.0” w.c.) on propane gas.

Failure to Ignite

1. For the initial start-up, or after unit has been off long periods of time, the first ignition trial may be unsuccessful due to need to purge air from manifold at start-up.
2. If ignition does not occur on the first trial, the gas and spark are shut-off by the ignition control and the control enters an inter-purge period of 15 to 90 seconds, during which the draft inducer continues to run.
3. At the end of the inter-purge period, another trial for ignition will be initiated.
4. Control will initiate up to three ignition trials on a call for heat before lockout of control occurs.
5. Control can be brought out of lockout by turning thermostat or controller to its lowest position and waiting 5 seconds and then turning back up to call for heat. Some controls provided will automatically reset after one hour and initiate a call for heat.

Burner Flames

Prior to completing the start-up, check the appearance of the main burner flame. See Figure 47 – 2.2mmHg (1.2” w.c.) Manifold and Figure 49 -6.5 mmHg (3.5” w.c.) Manifold for flame characteristics of properly adjusted natural gas systems.



Burner Flame @ Start-up 1.2” w.c. Manifold
Pressure Draft Inducer – High Speed

Figure 47 – 2.2mmHg (1.2” w.c.) Manifold
Natural Gas

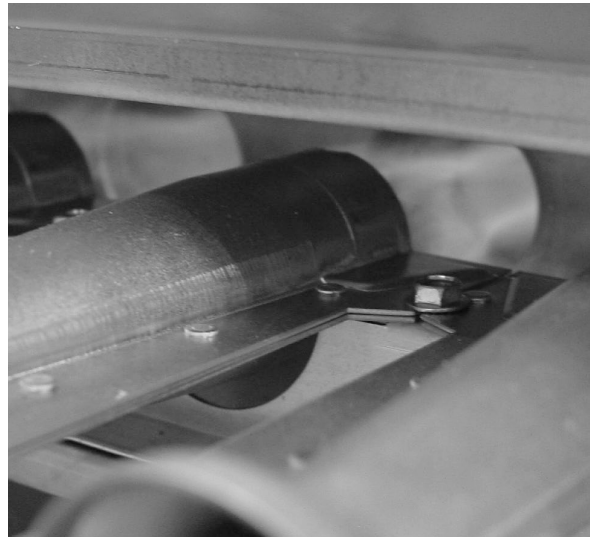

Burner Flame @ High Fire 3.5” w.c. Manifold
Pressure Draft Inducer – High Speed

Figure 48 -6.5 mmHg (3.5” w.c.) Manifold
Natural Gas

1. The burner flame should be predominately blue in color and well defined and centered at the tube entry as shown in Figure 47 – 2.2mmHg (1.2” w.c.) Manifold and Figure 49 -6.5 mmHg (3.5” w.c.) Manifold. Distorted flame or yellow tipping of natural gas flame, or a long yellow flame on propane, may be caused by lint and dirt accumulation inside burner or at burner ports, at air inlet between burner and manifold pipe, or debris in the main burner orifice. Soft brush or vacuum clean affected areas after performing Shutdown procedure.
2. Poorly defined, substantially yellow flames, or flames that appear lazy, indicate poor air supply to burners or excessive burner input. Verify gas supply type and manifold pressure with rating plate.
3. Poor air supply can be caused by obstructions or blockage in heat exchanger tubes or vent discharge pipe. Inspect and clean as necessary by to eliminate blockage. Vacuum any dirt or loose debris found in the tubes or vents. Clean heat exchanger tubes with stiff brush after performing Shutdown procedure. Poor flame characteristics can also be caused by undersized combustion air openings or flue gas recirculation into combustion air supply. Increase air opening size or re-direct flue products to prevent re-circulation.
4. Reduced air delivery can also be the result of fan blade slippage, dirt accumulation the fan blade or low voltage to draft inducer motor. Inspect draft fan assembly and be sure fan blade is secure to motor shaft. Check line voltage to heater.

! WARNING

Do not store or use gasoline or other flammable vapors and liquids in the vicinity of this or any other appliance.

Gas Heater Shut Down

1. Set thermostat or controller to lowest setting.
2. Turn off electrical supply to unit at disconnect switch.
3. Turn off manual gas supply (supplied by others).
4. Disconnect manifold and inlet pressure taps and re-install pipe plugs.
5. Close module door.

Normal Operation

1. Turn on electrical supply to unit at disconnect switch.
2. Turn on manual gas supply (supplied by others).
3. Set Thermostat or Temperature controller to desired temperature.

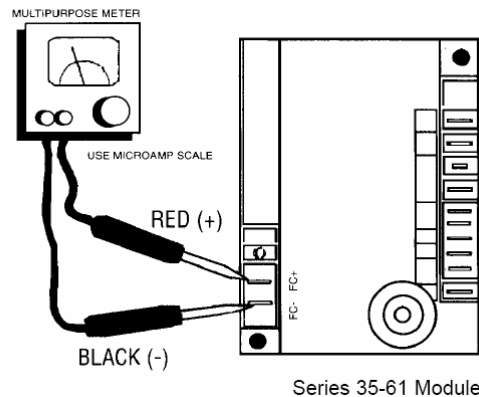

Figure 49 - Flame Sensor Current Check

Service Checks

Flame current is the current which passes through the flame from the sensor to ground. The minimum flame current necessary to keep the system from lockout is 0.7 microamps. To measure flame current, connect an analog DC microammeter to the FC- and FC+ terminals per figure. Meter should read 0.7 uA or higher. If the meter reads below "0" on scale, meter leads are reversed. Disconnect power and reconnect meter leads for proper polarity.

Air Pressure Switch

An air pressure switch is provided as part of the control system to verify airflow through draft inducer by monitoring the difference in pressure between the draft inducer and the atmosphere. If sufficient negative pressure is not present, indicating lack of proper air movement through heat exchanger, the switch opens shutting off gas supply through the ignition control module. On units with two speed draft inducer operation, a dual air pressure switch is used, monitoring high and low speed pressures. The air pressure switches have fixed settings and are not adjustable.

Rollout Switch (Manual Reset)

The gas furnace is equipped with manual reset rollout switches in the event of burner flame rollout. The switch will open on

temperature rise and shut-off gas supply through the ignition control module. Flame rollout can be caused by insufficient airflow for the burner firing rate (high gas pressure), blockage of the vent system or in the heat exchanger. The gas furnace should not be placed back in operation until the cause of rollout condition is identified. The rollout switch can be reset by pressing the button on the top of the switch.

High Limit Switch

The gas furnace is equipped with a fixed temperature high limit switch mounted on the vestibule panel that shuts off gas to the heater through the ignition control module in the event of reduced circulating airflow over the heat exchanger. Reduced airflow may be caused by dirty or blocked filters, restriction of the air inlet or outlet to the unit, or incorrect setting of the circulating air fan speed. The high limit switch will automatically reset when the temperature drops to -1.1°C (30°F) below the set point. Determine the cause of the reduced air flow and correct.

Ignition Control Diagnostics and Service Guide (Fenwal 35-61 Series). LED flashes on for ¼ second, and off for ¼ second during fault condition. Pause between fault codes is 3 seconds.

Table 17 - Gas Heater Troubleshooting

LED Code	System	Description	Actions
None	No Power to T1	On call for heat nothing happens	<ol style="list-style-type: none"> 1. Check for open fuse or circuit breaker. 2. Check for poor wiring connection. 3. Check for failed 24V transformer.
	Open Limit Switch	Thermostat call for heat. No power across terminals V1 / V2 control.	<ol style="list-style-type: none"> 1. Check for proper operation of circulating air supply system and for air filter blockage. 2. Check manifold pressure when limit cools and closes. Natural gas 3.5" w.c / LP gas 10.0" w.c. 3. Low combustion blower air output. Flue gas temp exceeds 550°F. Inspect for debris accumulation, proper wheel attachment, and proper voltage to blower.
Steady On	Internal Control Fault (No Operation)	24VAC across Terminal 24VAC / V2-Gnd when Thermostat calling for heat	Control fault – Replace ignition control.
1 Flash	Combustion Air Flow Fault	Pressure switch contacts in closed position for 30 seconds with no output to Combustion blower. Remains in this mode with combustion blower off.	<ol style="list-style-type: none"> 1. Check for short in wiring to pressure switch. 2. Check pressure switch for closed contacts (with leads disconnected). 3. Replace pressure switch
		Open pressure switch or flame rollout switch when inducer (IND terminal) is energized. If switch remains open for more than 30 seconds after combustion blower is energized, control will remain in this mode with IND terminal (blower) energized.	<ol style="list-style-type: none"> 1. Failed Combustion blower. 2. Check connections and air tube from draft inducer to air switch for leaks. 3. Check rollout switch manual reset - depress reset. 4. Check supply tube from draft inducer housing to pressure switches for condensate - drain line and re-connect. 5. Check pressure switch for condensate accumulation 6. Replace pressure switch
2 Flash	Flame Fault (No Call for Heat)	Flame sense failure / flame present with no call for heat.	<ol style="list-style-type: none"> 1. Check for voltage to gas valve with thermostat in off position. Valve should not be powered. 2. If valve is not energized, check for gas flow (manifold pressure reading greater than 0). If gas flow, turn off main shut-off valve and replace gas valve.
3 Flash	Ignition Lockout	<p>Failure to light and or carryover.</p> <p>Loss of flame or flame signal during ignition or operation cycle.</p> <p>Control will initiate up to 3 ignition re-trials before lockout.</p>	<ol style="list-style-type: none"> 1. Verify gas supply available and operation of gas valve - manifold pressure at start of ignition cycle. Check for power to valve terminals LO & COM while spark is energized. 2. Is spark present? - If not check igniter for debris between electrodes, cracked ceramic and check ignition wire for short to ground. 3. Check flame sensor wiring connections to electrode and control and for any abrasions. 4. Check for cracked ceramic on flame sensor or grounded sensor rod. 5. Verify that ample air supply and proper venting of flue gases occurs during operating cycle. 6. Check for circulating air leaks into burner compartment during operation. 7. Check for re-circulation of flue gases into combustion air supply. 8. If all conditions satisfactory – replace ignition control.

Operating Control Systems

Two Stage (TN) - Low / High Fire / High Speed Inducer Only

Modulating (MD) - Modulating (25 to 100%) / 2 Speed Draft Inducer - Mid-Fire Start (55%)

Modulating (MH) - Modulating (25 to 100%) / 2 Speed Draft Inducer - High Fire Start (100%)

Refer to unit wiring diagrams located in unit door.

Commissioning

The commissioning of an air conditioning system is the process of achieving, verifying, and documenting the performance of that system to meet the operational needs of the building. This may not be a formal process in smaller structures, but some form of owner acceptance will occur. Adjustments made during the commissioning phase may include air or water balancing, or configuration of controls and operational sequences.

Air Balancing

High performance systems commonly have complex air distribution and fan systems. Unqualified personnel should not attempt to adjust fan operation or air circulation, as all systems have unique operating characteristics. Professional air balance specialists should be employed to establish actual operating conditions and to configure the air delivery system for optimal performance.

Water Balancing

A hydronic specialist with a complete working knowledge of water systems, controls, and operation must be employed to properly balance the entire system. Unqualified personnel should not attempt to

manipulate temperatures, pressures, or flow rates, as all systems have unique operating characteristics and improper balancing can result in undesirable noises and operation.

Controls

A variety of controls and electrical accessories may be provided with the equipment.

Identify the controls on each unit by consulting appropriate submittal and order documents, and operate according to the control manufacturer's instructions. If you cannot locate installation, operation, or maintenance information for the specific controls, then contact your sales representative, or the control manufacturer, for assistance.

Operation

Immediately following building occupancy, the air conditioning system requires a maintenance schedule to assure continued successful operation. Routine maintenance of this equipment is necessary in order to provide continued efficient and reliable operation for the owner. See the Maintenance List provided later in this manual.

Adjusting Refrigerant Charge

Adjusting the charge of a system in the field must be based on determination of liquid sub-cooling and evaporator superheat. On a system with a TXV liquid sub-cooling is more representative of the charge than evaporator superheat but both measurements must be taken.

Before Charging

Unit being charged must be at or near full load conditions before adjusting the charge.

! CAUTION

The Clean Air Act of 1990 bans the intentional venting of refrigerant (CFC's and HCFC's) as of July 1, 1992. Approved methods of recovery, recycling or reclaiming must be followed. Fines and/or incarceration may be levied for non-compliance.

Units equipped with hot gas reheat must be charged with the hot gas reheat valves closed while the unit is in cooling mode to get the proper charge. After charging, unit should be operated in reheat (dehumidification) mode to check for correct operation.

After adding or removing charge the system must be allowed to stabilize, typically 10-15 minutes, before making any other adjustments.

The type of unit and options determine the ranges for liquid sub-cooling and evaporator superheat. Refer to the tables below when determining the proper sub-cooling.

Checking Liquid Sub-Cooling

Measure the temperature of the liquid line as it leaves the condenser.

Read the gauge pressure at the liquid line close to the point where the temperature was taken. Use liquid line pressure as it will vary from discharge pressure due to condenser pressure drop.

Convert the pressure obtained to a saturated temperature using the appropriate refrigerant temperature-pressure chart.

Subtract the measured liquid line temperature from the saturated temperature to determine the liquid sub-cooling.

Compare calculated sub-cooling to the table below for the appropriate unit type and options.

Table 18 - Acceptable Refrigeration Circuit Values (Metric)

	Cooling Mode Liquid Sub-Cooling Values
Cooling Only Unit ⁴	4.4-8.3°C
Cooling Only Unit with Hot Gas Reheat ^{1,4}	2.8-8.3°C
Heat Pump Unit ^{2,4}	1.1-2.2°C
Heat Pump Unit with Hot Gas Reheat ^{3,4}	1.1-3.3°C
Cooling Only Unit with LAC ⁴	4.4-8.3°C
Cooling Only Unit with Hot Gas Reheat & LAC ⁴	4.4-8.3°C

Table 19 - Acceptable Refrigeration Circuit Values (Imperial)

	Cooling Mode Liquid Sub-Cooling Values
Cooling Only Unit ⁴	8-15°F
Cooling Only Unit with Hot Gas Reheat ^{1,4}	5-15°F
Heat Pump Unit ^{2,4}	2-4°F
Heat Pump Unit with Hot Gas Reheat ^{3,4}	2-6°F
Cooling Only Unit with LAC ⁴	8-15°F
Cooling Only Unit with Hot Gas Reheat & LAC ⁴	8-15°F

Notes:

1. Must be charged with the hot gas valve closed. After charging, unit should be operated in reheat (dehumidification) mode to check for correct operation.
2. The sub-cooling value in this table is for the unit running in cooling mode of operation. After charging, unit should be operated in heating mode to check for correct operation.

- The sub-cooling value in this table is for the unit running in cooling mode of operation and the hot gas valve closed. After charging, unit should be operated in reheat (dehumidification) mode to check for correct operation and then in heating mode to check for correct operation.

Sub-cooling must be increased by .6°C (1°F) per 3 meters (10 feet) of vertical liquid line rise for R-410A (AHU above CU). For example, a cooling only unit with hot gas reheat and a vertical liquid drop can charge to a sub-cooling value of 2.8-8.3°C (5-15°F), but a cooling only unit with hot gas reheat and a vertical liquid rise of 9.1 m (30 ft) must charge to a sub-cooling value of at least 4.4-8.3°C (8-15°F).

Table 20 - Acceptable Water-Cooled Refrigeration Circuit Values (Metric)

	Water-Cooled Condenser
Sub-Cooling	3.3-5.6°C
Sub-Cooling with Hot Gas Reheat	4.4-6.7°C
Superheat	4.4-8.3°C

Table 21 - Acceptable Water-Cooled Refrigeration Circuit Values (Imperial)

	Water-Cooled Condenser
Sub-Cooling	6-10°F
Sub-Cooling with Hot Gas Reheat	8-12°F
Superheat	8-15°F

Checking Evaporator Superheat

Measure the temperature of the suction line close to the compressor.

Read gauge pressure at the suction line close to the compressor.

Convert the pressure obtained to a saturated temperature using the appropriate refrigerant temperature-pressure chart.

Subtract the saturated temperature from the measured suction line temperature to determine the evaporator superheat.

For refrigeration systems with tandem compressors, it is critical that the suction superheat setpoint on the TXV is set with one compressor running. The suction superheat should be 5.6 – 7.2°C (10-13°F) with one compressor running. The suction superheat will increase with both compressors in a tandem running. Inadequate suction superheat can allow liquid refrigerant to return to the compressors which will wash the oil out of the compressor. Lack of oil lubrication will destroy a compressor. Liquid sub-cooling should be measured with both

compressors in a refrigeration system running.

Compare calculated superheat to the acceptable cooling mode superheat values of 4.4-8.3°C (8-15°F) for all system types. Superheat will increase with long suction line runs.

 CAUTION
Thermal expansion valve must be adjust to between 4.4 and 8.3°C (8-15°F) of suction superheat. Failure to have sufficient superheat will damage the compressor and void the warranty.

Adjusting Sub-Cooling and Superheat Temperatures

The system is overcharged if the sub-cooling temperature is too high and the evaporator is fully loaded (low loads on the evaporator result in increased sub-cooling) and the evaporator superheat is within the temperature range as shown in the table above (high superheat results in increased sub-cooling).

Correct an overcharged system by reducing the amount of refrigerant in the system to lower the sub-cooling.

 CAUTION
DO NOT OVERCHARGE!
Refrigerant overcharging leads to excess refrigerant in the condenser coils resulting in elevated compressor discharge pressure.

The system is undercharged if the superheat is too high and the sub-cooling is too low

Correct an undercharged system by adding refrigerant to the system to reduce superheat and raise sub-cooling.

If the sub-cooling is correct and the superheat is too high, the TXV may need adjustment to correct the superheat. Before adjusting the TXV, verify the sensing bulb is in the correct position according to Figure 20 and follows the guidelines below.

1. The suction line is clean where the sensing bulb is attached.
2. The entire length of the sensing bulb is in contact with the suction line.
3. The sensing bulb should be placed several inches downstream of the equalizer line.
4. The sensing bulb is fully insulated.
5. If the sensing bulb is installed on a vertical portion of the suction line, the sensing bulb should be placed upstream of a suction line trap.

Table 22 - R-410A Refrigerant Temperature-Pressure Chart (Metric)

°C	KPA	°C	KPA	°C	KPA	°C	KPA	°C	KPA
-6.7	539.9	8.3	928.8	23.3	1473.5	38.3	2213.3	53.3	3193.8
-6.1	551.6	8.9	946.0	23.9	1496.9	38.9	2245.0	53.9	3235.8
-5.6	564.0	9.4	963.2	24.4	1521.0	39.4	2276.7	54.4	3277.9
-5.0	576.4	10.0	980.5	25.0	1545.2	40.0	2309.1	55.0	3320.6
-4.4	588.8	10.6	998.4	25.6	1570.0	40.6	2341.5	55.6	3363.4
-3.9	601.2	11.1	1016.3	26.1	1594.8	41.1	2374.6	56.1	3406.8
-3.3	614.3	11.7	1034.9	26.7	1619.6	41.7	2408.4	56.7	3450.9
-2.8	627.4	12.2	1053.6	27.2	1645.1	42.2	2442.2	57.2	3495.1
-2.2	640.5	12.8	1072.2	27.8	1670.7	42.8	2476.0	57.8	3539.9
-1.7	654.3	13.3	1090.8	28.3	1696.2	43.3	2510.5	58.3	3585.4
-1.1	667.4	13.9	1110.1	28.9	1722.4	43.9	2544.9	58.9	3630.9
-0.6	681.2	14.4	1129.4	29.4	1749.3	44.4	2580.1	59.4	3677.1
0.0	695.7	15.0	1149.4	30.0	1775.5	45.0	2616.0	60.0	3724.0
0.6	709.5	15.6	1169.4	30.6	1802.4	45.6	2651.8	60.6	3771.6
1.1	724.0	16.1	1189.4	31.1	1829.9	46.1	2688.4	61.1	3819.1
1.7	738.5	16.7	1209.4	31.7	1857.5	46.7	2724.9	61.7	3867.4
2.2	752.9	17.2	1230.1	32.2	1885.8	47.2	2761.4	62.2	3915.7
2.8	768.1	17.8	1251.4	32.8	1914.1	47.8	2798.7	62.8	3965.3
3.3	783.3	18.3	1272.1	33.3	1942.3	48.3	2836.6	63.3	4015.0
3.9	798.4	18.9	1293.5	33.9	1971.3	48.9	2874.5	63.9	4065.3
4.4	814.3	19.4	1314.9	34.4	2000.2	49.4	2913.1	64.4	4115.6
5.0	829.5	20.0	1336.9	35.0	2029.9	50.0	2952.4	65.0	4167.3
5.6	846.0	20.6	1359.0	35.6	2059.5	50.6	2991.7	65.6	4219.1
6.1	861.9	21.1	1381.8	36.1	2089.2	51.1	3031.0		
6.7	878.4	21.7	1403.8	36.7	2120.2	51.7	3071.0		
7.2	895.0	22.2	1427.3	37.2	2150.6	52.2	3111.7		
7.8	911.5	22.8	1450.0	37.8	2181.6	52.8	3153.1		

Table 23 - R-410A Refrigerant Temperature-Pressure Chart (Imperial)

°F	PSIG	°F	PSIG	°F	PSIG	°F	PSIG	°F	PSIG
20	78.3	47	134.7	74	213.7	101	321.0	128	463.2
21	80.0	48	137.2	75	217.1	102	325.6	129	469.3
22	81.8	49	139.7	76	220.6	103	330.2	130	475.4
23	83.6	50	142.2	77	224.1	104	334.9	131	481.6
24	85.4	51	144.8	78	227.7	105	339.6	132	487.8
25	87.2	52	147.4	79	231.3	106	344.4	133	494.1
26	89.1	53	150.1	80	234.9	107	349.3	134	500.5
27	91.0	54	152.8	81	238.6	108	354.2	135	506.9
28	92.9	55	155.5	82	242.3	109	359.1	136	513.4
29	94.9	56	158.2	83	246.0	110	364.1	137	520.0
30	96.8	57	161.0	84	249.8	111	369.1	138	526.6
31	98.8	58	163.8	85	253.7	112	374.2	139	533.3
32	100.9	59	166.7	86	257.5	113	379.4	140	540.1
33	102.9	60	169.6	87	261.4	114	384.6	141	547.0
34	105.0	61	172.5	88	265.4	115	389.9	142	553.9
35	107.1	62	175.4	89	269.4	116	395.2	143	560.9
36	109.2	63	178.4	90	273.5	117	400.5	144	567.9
37	111.4	64	181.5	91	277.6	118	405.9	145	575.1
38	113.6	65	184.5	92	281.7	119	411.4	146	582.3
39	115.8	66	187.6	93	285.9	120	416.9	147	589.6
40	118.1	67	190.7	94	290.1	121	422.5	148	596.9
41	120.3	68	193.9	95	294.4	122	428.2	149	604.4
42	122.7	69	197.1	96	298.7	123	433.9	150	611.9
43	125.0	70	200.4	97	303.0	124	439.6		
44	127.4	71	203.6	98	307.5	125	445.4		
45	129.8	72	207.0	99	311.9	126	451.3		
46	132.2	73	210.3	100	316.4	127	457.3		

Refrigeration Troubleshooting

Table 24 – Refrigeration Problems, Causes, and Solutions

Problem	Possible Cause	Solutions
Frosted evaporator coil, low suction pressure	Restricted air flow Low fan speed Reversed blower rotation Low refrigerant charge	Clean, or replace filters Check fan drives Correct wiring Add refrigerant
Unit runs, but supplies warm air	Loss of refrigerant Faulty expansion valve element Plugged filter-drier	Check leaks, add refrigerant Replace valve element Replace filter-drier
Compressor starts, but opens high pressure control	Refrigerant over-charged Air in condenser coil Condenser fan faulty Condenser coil dirty	Remove some refrigerant Evacuate and recharge refrigerant Replace fan motor Clean condenser coil
High suction pressure, but low superheat	Oversized expansion valve Poor sensing bulb location Low superheat adjustment	Replace with correct expansion valve Relocate sensing bulb, secure to suction line Adjust expansion valve
Unit operates continuously	Low refrigerant charge Unit undersized	Check and recharge to nameplate Decrease load or resize unit Thermostat set too low, increase temperature setting

Maintenance

(See back of the manual for maintenance log.)

At least once each year, a trained, qualified service technician should check out the unit. Fans, evaporator coils, and filters should be inspected at least monthly.

One week after start-up:

- Check operating pressures.
- Adjust belt tension on all fan drives.
- Check filters for cleanliness. Measure pressure loss if applicable. Replace if necessary.
- Check cycling of compressors, fans, and valves. Correct unusual cycling.

Monthly:

- Lubricate bearings if operating continuously at 1500 rpm, or higher, or in other extreme conditions.
- Check cleanliness of filters and replace if necessary.
- Check cooling coil drain pan to assure proper drainage.
- Inspect all coils. Clean if dirty or obstructed in any way.

Quarterly:

- Lubricate bearings if operating at 1000 rpm, or less, and in temperatures less than 65.6°C (150°F), or other extreme conditions.
- Check damper operation for freedom of movement. Correct any binding that may occur.
- Check belts and pulleys on fan drives for tension and unusual wear.
- Check operation of heating and cooling sections.
- Check inlet and outlet air temperatures.

Annually:

- Clean the coils with water or non-corrosive coil cleaner.
- Clean the drain line, “P” trap, and condensate pan.

- Check refrigerant pressures and temperatures every Spring.
- Check heating section every Fall. Check all electrical connections for tightness and check heater elements for indications of overheating.

Fan Assembly

M2 Series units use backward curved fan wheels which are non-overloading, energy efficient and easy to clean. Cleaning the wheels is necessary to reduce electrical use, maintain capacity, and reduce stress on the unit. The wheel and fan section need to be inspected periodically and cleaned of dust or debris.

To inspect and clean the blower, set thermostat to the “OFF” position. Turn the electrical power to the unit to the “OFF” position at the disconnect switch. Clean the assembly. Check the bearings. Inspect the belt condition and tightness. Check screws for tightness. Rotate blower wheels while listening closely to each bearing to check for noise or roughness in the bearing, which can indicate a failing bearing.

Bearings

AAON uses pre-lubricated bearings, and bearings that have been sized for an average failure rate of 50% after 200,000 hours, or 22.8 years, of operation (see heading “Lubrication” in this section for more information). The bearing sizing tables below are based on rotational speeds and radial loading. However, the alignment of the bearing to the shaft and the security of the bearing inner race to the shaft will greatly affect bearing life. Even though the manufacturer is responsible for bearing tolerances and mounting design, **the servicer is advised to regularly check the security of the bearing locking system.**

Table 25 - Bearing Setscrew Torque Recommendations (Metric)

Shaft Size (millimeters)	Setscrew Locking	
	Thread	Torque (Nm)
25.4	1/4 - 28	7.3 - 9.4
30.2	1/4 - 28	7.3 - 9.4
36.5	5/16 - 24	13.9 - 18
47.6	3/8 - 24	25.1 - 32.6
Shaft Size (millimeters)	Skewzloc Locking	
	Thread	Torque (Nm)
25.4	8 - 32	6.9 - 7.7
30.2	8 - 32	6.9 - 7.7
36.5	10 - 24	8.9 - 10
47.6	1/4 - 20	17.8 - 19.8

Table 26 - Bearing Setscrew Torque Recommendations (Imperial)

Shaft Size (inches)	Setscrew Locking	
	Thread	Torque (in-lbs.)
1	1/4 - 28	66 - 85
1 3/16	1/4 - 28	66 - 85
1 7/16	5/16 - 24	126 - 164
1 7/8	3/8 - 24	228 - 296
Shaft Size (inch)	Skewzloc Locking	
	Thread	Torque (in-lbs.)
1	8 - 32	63 - 70
1 3/16	8 - 32	63 - 70
1 7/16	10 - 24	81 - 90
1 7/8	1/4 - 20	162 - 180

Belts

Belt drive misalignment is one of the most common causes of premature belt failure. A belt can be destroyed in a matter of days if the drives have been aligned incorrectly.

The most common tool for measuring misalignment is a straightedge. Hold the straightedge flush across one pulley to gauge the degree of misalignment of the two sheaves. The maximum allowed misalignment is one half degree of angular misalignment, and 1/10th of an inch per foot

between sheave centers for parallel misalignment.

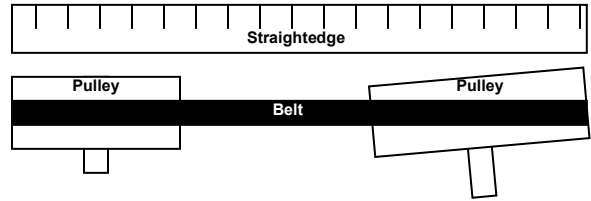

Figure 50 - Angular Misalignment

Correct by moving the position of the motor.

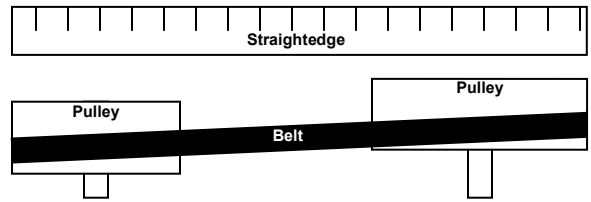

Figure 51 - Parallel Misalignment

Correct by adjusting sheaves on one, or both shafts.

Frequent belt tensioning is highly recommended. Most belt manufacturers would suggest a re-tensioning after as little as 8 hours of operation. A simplified method of adjusting tension is to gauge the amount of force required to deflect the belt by 1/64th of an inch per inch of distance between sheave centers. For example, if the sheaves are 20 inches apart, then the amount of deflection with the forces listed below is 20/64th (5/16th) of an inch.

Deflection required for

“A” belts: 4-6 lbs.

“B” belts: 6-10 lbs.

“C” belts: 10-18 lbs.

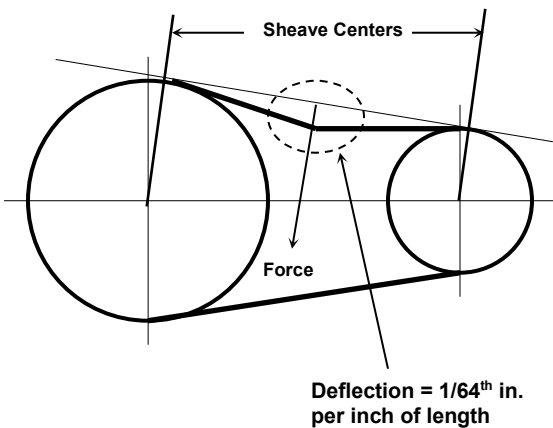

Figure 52 - Belt Deflection

Indoor Coils

Indoor cooling/evaporator coils must be cleaned regularly to maintain unit efficiency and operation. Dirty evaporator coils will eventually freeze up and often result in a time consuming and expensive service call. Clean filters will help to prevent dirt from accumulating on cooling coils, however cooling coils should be cleaned at least annually by an HVAC professional.

Refrigeration Cycle

Satisfactory performance of the refrigeration cycle can be determined by measuring suction line superheat. In order to determine if refrigerant flowing from the evaporator is dry, ensure that the system has enough refrigerant to produce liquid line subcooling, but not so much to cause abnormally high condensing temperatures (and pressures). Refrigerant cycle analysis is best performed in conditions that approach the conditions where the air conditioner will be expected to operate.

Brazed Plate Heat Exchanger Cleaning

Because of a normally high degree of turbulence in brazed plate heat exchangers, for many applications the heat exchanger channels are self-cleaning. For applications that are not self-cleaning (i.e. hard water at high temperatures, etc.) or applications where additional cleaning is desired, it is possible to

clean the brazed plate heat exchanger by circulating a cleaning liquid.

Use a tank with weak acid, 5% phosphoric acid (H₃PO₄) or, if the exchanger is frequently cleaned, 5% oxalic acid (H₂C₂O₄). Pump the cleaning liquid through the exchanger. For optimum cleaning, the cleaning solution flow rate should be a minimum of 1.5 times the normal flow rate, preferably in a back-flush mode. After cleaning, the heat exchanger must be rinsed with clean water. A solution of 1-2% sodium hydroxide (NaOH) or sodium bicarbonate (NaHCO₃) before the last rinse ensures that all acid is neutralized.

E-Coated Coil Cleaning

Documented routine cleaning of e-coated coils is required to maintain coating warranty coverage. E-Coated Coil Maintenance Record document is available on the AAON website.

! WARNING

Electric shock hazard. Shut off all electrical power to the unit to avoid shock hazard or injury from rotating parts.

Surface loaded fibers or dirt should be removed prior to water rinse to prevent restriction of airflow. If unable to back wash the side of the coil opposite of the coils entering air side, then surface loaded fibers or dirt should be removed with a vacuum cleaner. If a vacuum cleaner is not available, a *soft non-metallic* bristle brush may be used. In either case, the tool should be applied in the direction of the fins. Coil surfaces can be easily damaged (fin edges bent over) if the tool is applied across the fins.

Use of a water stream, such as a garden hose, against a surface loaded coil will drive the fibers and dirt into the coil. This will make cleaning efforts more difficult. Surface

loaded fibers must be completely removed prior to using low velocity clean water rinse.

A **monthly** clean water rinse is recommended for coils that are applied in coastal or industrial environments to help to remove chlorides, dirt, and debris. It is very important when rinsing, that water temperature is less than 54.4°C (130°F) and pressure is than 100 psig to avoid damaging the fin edges. An elevated water temperature (not to exceed 54.4°C [130°F]) will reduce surface tension, increasing the ability to remove chlorides and dirt.

 **CAUTION**

High velocity water from a pressure washer or compressed air should only be used at a very low pressure to prevent fin and/or coil damages. The force of the water or air jet may bend the fin edges and increase airside pressure drop. Reduced unit performance or nuisance unit shutdowns may occur.

Quarterly cleaning is essential to extend the life of an e-coated coil and is required to maintain coating warranty coverage. Coil cleaning shall be part of the unit's regularly scheduled maintenance procedures. Failure to clean an e-coated coil will void the warranty and may result in reduced efficiency and durability.

 **CAUTION**

Harsh chemicals, household bleach, or acid cleaners should not be used to clean outdoor or indoor e-coated coils. These cleaners can be very difficult to rinse out of the coil and can accelerate corrosion and attack the e-coating. If there is dirt below the surface of the coil, use the recommended coil cleaners.

For routine quarterly cleaning, first clean the coil with the below approved coil cleaner. After cleaning the coils with the approved cleaning agent, use the approved chloride remover to remove soluble salts and revitalize the unit.

Recommended Coil Cleaner

The following cleaning agent, assuming it is used in accordance with the manufacturer's directions on the container for proper mixing and cleaning, has been approved for use on e-coated coils to remove mold, mildew, dust, soot, greasy residue, lint and other particulate:

Enviro-Coil Concentrate, Part Number H-EC01.

Recommended Chloride Remover

CHLOR*RID DTS™ should be used to remove soluble salts from the e-coated coil, but the directions must be followed closely. This product is not intended for use as a degreaser. Any grease or oil film should first be removed with the approved cleaning agent.

Remove Barrier - Soluble salts adhere themselves to the substrate. For the effective use of this product, the product must be able to come in contact with the salts. These salts may be beneath any soils, grease or dirt; therefore, these barriers must be removed prior to application of this product. As in all surface preparation, the best work yields the best results.

Apply CHLOR*RID DTS - Apply directly onto the substrate. Sufficient product must be applied uniformly across the substrate to thoroughly wet out surface, with no areas missed. This may be accomplished by use of a pump-up sprayer or conventional spray gun. The method does not matter, as long as the entire area to be cleaned is wetted. After the substrate has been thoroughly wetted, the salts will be soluble and is now only necessary to rinse them off.

Rinse - It is highly recommended that a hose be used, as a pressure washer will damage the fins. The water to be used for the rinse is recommended to be of potable quality, though a lesser quality of water may be used if a small amount of CHLOR*RID DTS is added. Check with CHLOR*RID International, Inc. for recommendations on lesser quality rinse water.

Gas Furnace

WARNING

Improper installation, adjustment, alteration, service or maintenance can cause property damage, personal injury or loss of life. Startup and service must be performed by a Factory Trained Service Technician. A copy of this IOM should be kept with the unit.

WARNING

Disconnect all electrical power sources before servicing the unit. More than one power source may be provided. Failure to do so may result in injury or death from electrical shock or entanglement in moving parts.

CAUTION

If any original wiring needs to be replaced it must be replaced with wiring materials suitable for 105°C (221°F).

Label all wires prior to disconnection when servicing unit. Wiring errors can cause improper or dangerous operation. Verify proper operation after servicing.

Turn off all electrical power to the unit before inspection & servicing.

1. The gas furnace should be inspected annually by a qualified service agency. The condition of the burners, heat exchanger, draft inducer, vent system, operating controls and wiring should be determined. Check for obvious signs of deterioration, accumulation of dirt and debris and any heat or water related damage. Any damaged or deteriorated parts should be replaced before the unit is put back into service.
2. Clean burners, heat exchanger, draft inducer and vent ducts with a soft brush or vacuum.
3. Check Heat Exchanger for cracks. If any are present, replace heat exchanger before putting unit back into service.
4. Check wiring connections to be sure they are secure and inspect wiring for any deterioration.
5. Check the attachment point of the gas furnace to the cabinet or ducts to verify that they are air tight.
6. Check for gas tightness of all pipe joints and connections.
7. Check the automatic gas valve to insure that the gas valve seat is not leaking.

If gas heater is located downstream of cooling coils a condensate drain line should be connected to the flue collector box. Be sure the drain line is not obstructed. Clean any debris or blockage from the line.

Gas Furnace Operation Check

1. Turn on power to the unit and set thermostat or heat controller to call for heat, allowing gas furnace to operate.
2. Check for proper start-up and ignition as outlined in Start-Up section.
3. Check the appearance of the burner flame.
4. Check that the circulating air fan is operating and verify the proper airflow through gas furnace.

- Return thermostat or heat controller to normal setting.

Electric Heating

Set thermostat in the heat mode; call for heat to engage all electric heat strips. Check blower for proper rotation and voltage. Measure the amperage and voltage. Compare them to the nameplate data.

If applicable, check remote heat pump condenser as per the manufacturer's recommendations.

Steam or Hot Water Heating

Set thermostat in the heat mode. Observe supply blower for proper rotation and voltage. Check boiler or hot water operation according to the manufacturer's instructions. Check control flow valves for correct operation and settings per the manufacturer's instructions.

Cleaning

Inspect and clean unit interior at the beginning of each heating and cooling season and as operating conditions require.

Chilled Water

Check remote chiller operations as per the manufacturer's instructions. Check coolant flow valves for correct operation and settings.

DX Water Source Cooling

Set unit controls to cooling mode of operation with supply fans on. Check the fan for correct operating direction, amperage, and voltage. Check compressor operation, rotation, amperage, and voltage to the unit nameplate (check the amperage on the load side of the compressor contactor).

Condensate Drain Pans

Drain pans will have moisture present and require periodic cleaning to prevent microbial growth. Cleaning of the drain pans will also prevent any possible plugging of the drain lines and overflow of the pan itself. Cleaning of the drain pans and inside of the unit should be done only by a qualified service technician.

Lubrication

Most motors and bearings are permanently lubricated. Some applications may require that bearings be re-lubricated periodically. The schedule will depend on the operating duty, temperature variations, and other atmospheric conditions.

For bearings equipped with lubrication fittings, the lubrication schedule is dependent on operating temperatures and rotational speeds as shown in the table below. Lithium based grease conforming to an NLGI grade No. 2 consistency is recommended. This medium viscosity, low torque grease is rust inhibiting and water-resistant. It is satisfactory for operating temperatures in the range of -23.3 – 121.1°C (-10°F to 250°F).

Bearings should only be re-lubricated when at normal operating temperatures and not running. Rotate the fan shaft by hand, adding only enough grease to purge the seals. A one-inch bearing has a total grease capacity of only .25 ounces. Added grease should be limited to .09 ounces.

Table 27 - Min and Max Water Pressures and Temps

	Chilled Water	Hot Water
Min. Entering Air	15.6°C (60°F)	4.4 °C (40°F)
Max Entering Air	37.8°C (100°F)	26.7°C (80°F)
Min. Entering Water	1.7°C (35°F)	60°C (140°F)
Max Entering Water	18.3°C (65°F)	93.3°C (200°F)
Min. Water Pressure	0 kpa (15 psig)	
Max Water Pressure	2068kpa (300 psig)	

DO NOT OVER LUBRICATE.

Recommended greases are:
SHELL OIL - DOLIUM R
CHEVRON OIL - SRI No. 2
TEXACO INC. - PREMIUM RB

In the event the unit is not functioning correctly and a service company is required, only a company with service technicians qualified and experienced in both commercial heating and air conditioning should be permitted to service the systems in order to keep warranties in effect. The service tech may call the factory if assistance is required.

Table 28 - Fan Bearing Lubrication Schedule

Fan Speed	Temp °C	Temp. °F	Environ.	Greasing Interval
500 rpm	Up to 65.6	Up to 150	Clean	2 to 6 months
1000 rpm	Up to 99	Up to 210	Clean	2 weeks to 2 months
1500 rpm	Up to 99	Up to 210	Clean	Monthly
Any Speed	Up to 65.6	Up to 150	Dirty	1 week to 1 month
Any Speed	99 – 121.1	210 - 250	Dirty	Weekly

Phase and Brownout Protection Module



The DPM is a Digital Phase Monitor that monitors line voltages from 200VAC to 240VAC 1 ϕ and 200VAC to 600VAC 3 ϕ . The DPM is 50/60 Hz self-sensing. DPM should be wired according to unit specific wiring diagram include in the control compartment

When the DPM is connected to the line voltage, it will monitor the line and if everything is within the setup parameters, the output contacts will be activated. If the line voltages fall outside the setup parameters, the output relay will be de-energized after the trip delay.

Once the line voltages recover, the DPM will re-energize the output relay after the restart time delay. All settings and the last 4 faults are retained, even if there is a complete loss of power.

DPM Setup Procedure

With the supply voltage active to the module, you can setup all of the DPM's settings without the line voltage connected.

To change the setpoint parameters use the right arrow key to advance forward through the setpoint parameters and the left arrow to backup if needed. When each parameter is displayed use the up/down keys to change and set the parameter.

After adjustments are made or if no adjustments are made it will take 2 to 4 minutes before the DPM energizes the output relay unless there is an out of tolerance issue with the incoming line voltage.

Recommended Default Set-up

Line Voltage	460VAC, 3 ϕ
Over & Undervoltage	\pm 10%
Trip Time Delay	5 Seconds
Re-Start Time Delay	2 Minutes
Phase Imbalance	5%

Replacement Parts

Parts for AAON equipment may be obtained from your local AAON representative. When ordering parts, reference the unit serial number and part number.

AAON Technical Support

203 Gum Springs Rd.
Longview, TX 75602
Ph: (918) 382-6450
techsupport@AAON.com
www.AAON.com

Note: Before calling, technician should have model and serial number of the unit available for the service department to help answer questions regarding the unit.

Warranty: Refer to the Limited Warranty Certificate for the unit warranty details. Contact your AAON representative for a unit specific copy of the certificate for your serial number.



Limited Warranty Certificate

GENERAL CONDITIONS

AAON, Inc. (hereinafter referred to as "AAON") warrants this AAON equipment, as identified hereon, to be free of defects in material and workmanship under normal use, service, and maintenance. Our obligations under this warranty must be limited to repairing or replacing the defective part, or parts, which in our judgment show evidence of such defects. AAON is not liable for labor charges and other costs incurred for removing, shipping, handling or transporting defective part, or parts, or for shipping, handling, transporting, or installing repaired or replacement part, or parts.

The limited warranty is effective one (1) year from date of **original installation**, or eighteen (18) months from date of original shipment from the factory, whichever occurs first and covers all parts and components in this AAON equipment excluding air filters, belts, refrigerant moisture driers, and lost refrigerant, which are not included in any part of this limited warranty. The replacement part, or parts, assume only the unused portion of the original limited warranty and are shipped f.o.b. from the factory and freight prepaid by the factory.

The limited warranty is effective for products manufactured at the Tulsa, Oklahoma or Longview, Texas facility.

THIS LIMITED WARRANTY ONLY APPLIES WHEN THE **ORIGINAL MODEL NUMBER AND SERIAL NUMBER** OF THE AAON UNIT ARE GIVEN AT TIME OF REQUEST FOR REPLACEMENT PART, OR PARTS. DEFECTIVE PART, OR PARTS, MUST BE RETURNED **PREPAID**, WITH ITS ASSIGNED RETURN MATERIAL TAG, WITHIN FOURTEEN (14) DAYS OF RECEIPT OF THE REPLACEMENT PART, OR PARTS.

EXTENDED LIMITED WARRANTY ON COMPRESSORS INCLUDED IN SINGLE PACKAGE EQUIPMENT (NOT INCLUDING CHILLERS OR WH/WV); OPTIONAL ON OTHER EQUIPMENT

For the second through the fifth year from date of **shipment**, we further agree to repair or replace the fully hermetic compressor, at our option, for the **original purchaser-user only**. The repaired or replacement fully hermetic compressor will be supplied f.o.b. the factory, freight **prepaid and add**, providing the defective fully hermetic compressor is returned **prepaid by the customer**, and is proven to be inoperative due to defects in materials or workmanship. This extended limited warranty covers **only** the fully hermetic compressor and **does not include** any labor charges, or other additional costs incurred for removing, shipping, handling, transporting, or replacing the defective fully hermetic compressor. It also **does not include** additional costs incurred for shipping, handling, or transporting of electric controls such as relays, capacitors, pressure controls, or fan-motor assemblies, condensers, receivers, etc, which carry the standard **one-year limited warranty**.

EXTENDED LIMITED WARRANTY OF WH/WV PRODUCTS

The WH/WV limited warranty is effective five (5) years from date of original installation. If installation date cannot be verified, limited warranty is effective five (5) years from date of equipment manufacture at the factory. Warranty covers all parts and components, including compressors, in this AAON equipment except those excluded in the general conditions.

EXTENDED LIMITED WARRANTY OF RQ PRODUCTS

The RQ limited warranty is effective two (2) years from date of original **shipment** from the factory and covers all parts and components in this AAON equipment except those excluded in the general conditions.

FOR OPTIONAL TWO YEAR EXTENDED LIMITED WARRANTY OF RN PRODUCTS

The limited warranty is effective two (2) years from date of original **shipment** from the factory and covers all parts and components in this AAON equipment except those excluded in the general conditions.

FOR OPTIONAL FIVE YEAR EXTENDED LIMITED WARRANTY OF RN or RQ PRODUCTS

The limited warranty is effective five (5) years from date of original **shipment** from the factory and covers all parts and components in this AAON equipment except those excluded in the general conditions.

FOR OPTIONAL TEN YEAR EXTENDED LIMITED WARRANTY OF RN or RQ PRODUCTS

The limited warranty is effective ten (10) years from date of original **shipment** from the factory and covers all parts and components in this AAON equipment except those excluded in the general conditions.

FOR OPTIONAL FIVE YEAR EXTENDED LIMITED WARRANTY OF RN OR RQ ECONOMIZER WITH FAULT DETECTION AND DIAGNOSTICS

For the second through fifth year from date of shipment, we further warrant the economizer damper assembly against failure due to defects in materials and workmanship for the original purchaser-user only.

EXTENDED LIMITED WARRANTY OF GAS FIRED HEAT EXCHANGERS

FOR RQ OR RN ALUMINIZED STEEL HEAT EXCHANGERS

For the second through the fifteenth year from date of **shipment**, we further warrant the steel heat exchanger against failure due to defects in materials and workmanship for the **original purchaser-user only**.

FOR RQ, RN, OR RZ STAINLESS STEEL HEAT EXCHANGERS

For the second through the twenty-fifth year from date of **shipment**, we further warrant the stainless steel heat exchanger against failure due to defects in materials and workmanship for the **original purchaser-user only**.

FOR RL SERIES HEAT EXCHANGERS

For the second through the tenth year from date of original installation, we further warrant the steel heat exchanger against failure due to defects in materials and workmanship for the original purchaser-user only, in accordance with the following: For the first five (5) years from date of shipment, we agree to repair or replace the heat exchanger, at our option, for the original purchaser-user only; during the sixth year, we will charge 50% of the current trade price for repaired or replacement steel heat exchanger, as the case may be, during the seventh year, 60%, during the eighth year, 70% during the ninth year, 80% and during the tenth year, 90%.

In all cases, the repaired or replacement heat exchanger will be supplied f.o.b. our factory, freight prepaid, providing the defective heat exchanger is returned **prepaid**, and if it is proven to be inoperative due to defects in materials and workmanship. This extended limited warranty covers **only** the heat exchanger and **does not include** labor charges, or other costs incurred for removing, shipping, handling, transporting, or installing repaired replacement heat exchanger. This extend limited warranty **does not apply** where the furnace has been operated in an atmosphere contaminated by chlorine, fluorine, or any other damaging chemical compounds.

FOR OPTIONAL FIVE YEAR EXTENDED LIMITED WARRANTY OF COIL COATING

For the second through fifth year from date of shipment, we further warrant the coating of e-coated coils on the equipment against failure due to defects in materials and workmanship for the original purchaser-user only. Coil cleaning, maintenance, and record keeping must be followed according to the unit Installation, Operation and Maintenance Manual to maintain warranty.



Limited Warranty Certificate

OTHER CONDITIONS

This warranty **does not cover** any AAON unit or part thereof which has been subject to accident, negligence, damages in transit, misuse or abuse, **or which has been tampered with or altered in any way**, or which has not been installed operated serviced and maintained in accordance with our instructions, or which has been installed outside of the Continental United States or Canada, or on which the serial number or identification number has been altered defaced, or removed. AAON will not be responsible for failure of the unit to start due to voltage conditions, blown fuses, open circuit breakers, or other damages due to the inadequacy or interruption of electric service.

This warranty **does not cover** equipment containing a water-to-refrigerant heat exchanger for any damage resulting from freezing, fouling, corrosion or clogging.

AAON must not be liable for any default or delay in performance hereunder, caused by a contingency beyond its control, including governmental restrictions or restraint, strikes, short or reduced supply of raw materials or parts, floods, winds, fire, lightning strikes, or any other acts of God.

DISCLAIMERS OF WARRANTIES

THIS WARRANTY IS EXCLUSIVE AND IS IN LIEU OF ANY WARRANTY OF MERCHANTABILITY, FITNESS FOR A PARTICULAR PURPOSE OR OTHER WARRANTY OF QUALITY, WHETHER EXPRESS OR IMPLIED, EXCEPT OF TITLE AND AGAINST PATENT INFRINGEMENT. CORRECTION OF NON-CONFORMITIES ARE LIMITED TO REPAIR OR REPLACEMENT OF THE DEFECTIVE PART OR PARTS, AT SELLER'S OPTION, WHICH MUST CONSTITUTE FULFILLMENT OF ALL TORT OR OTHERWISE IT IS EXPRESSLY UNDERSTOOD THAT AAON MUST NOT BE LIABLE FOR ANY CONSEQUENTIAL OR INCIDENTAL DAMAGES. AAON MUST NOT UNDER ANY CIRCUMSTANCES BE LIABLE FOR SPECIAL, INCIDENTAL OR CONSEQUENTIAL DAMAGES, SUCH AS, BUT NOT LIMITED TO DAMAGES OR LOSS OF OTHER PROPERTY OR EQUIPMENT, LOSS OF PROFITS OR REVENUE, COST OF CAPITAL, COST OF PURCHASED OR REPLACEMENT GOODS, OR CLAIMS OF BUYER OR USER FOR SERVICE INTERRUPTIONS. THE REMEDIES OF THE BUYER SET FORTH HEREIN ARE EXCLUSIVE, AND THE LIABILITY OF AAON WITH RESPECT TO ANY CONTRACT, OR ANYTHING DONE IN CONNECTION THEREWITH SUCH AS THE PERFORMANCE OR BREACH THEREFORE, OR FROM THE MANUFACTURE, SALE, DELIVERY, RESALE, INSTALLATION, OR USE OF ANY GOODS COVERED BY OR FURNISHED UNDER THIS CONTRACT WHETHER ARISING OUT OF CONTRACT, NEGLIGENCE, STRICT TORT, OR UNDER ANY WARRANTY, OR OTHERWISE, MUST NOT EXCEPT AS EXPRESSLY PROVIDED HEREIN, EXCEED THE PRICE OF THE GOODS UPON WHICH SUCH LIABILITY IS BASED.

WITH RESPECT TO THE GOODS SOLD, THE BUYER HEREBY WAIVES ALL LIABILITY ARISING FROM STATUTE, LAW, STRICT LIABILITY IN TORT, OR OTHERWISE, INCLUDING WITHOUT LIMITATION ANY OBLIGATION OF AAON WITH RESPECT TO CONSEQUENTIAL OR INCIDENTAL DAMAGES AND WHETHER OR NOT OCCASIONED BY AAON NEGLIGENCE. TIME LIMIT ON COMMENCING LEGAL ACTIONS: AN ACTION FOR BREACH OF THIS CONTRACT FOR GOOD SOLD OR ANY OTHER ACTION OTHERWISE ARISING OUT OF THIS CONTRACT, MUST BE COMMENCED WITHIN ONE (1) YEAR FROM THE DATE, THE RIGHT, CLAIM, DEMAND OR CAUSE OF ACTION MUST FIRST OCCUR, OR BE BARRED FOREVER.

SEVERABILITY

IF ANY PROVISION OR CAUSE OF THIS CONTRACT OR APPLICATION THEREOF TO ANY PERSON OR CIRCUMSTANCES IS HELD INVALID OR UNCONSCIONABLE SUCH INVALIDITY OR UNCONSCIONABILITY MUST NOT AFFECT OTHER PROVISIONS OR APPLICATIONS OF THE CONTRACT WHICH CAN BE GIVEN EFFECT WITHOUT THE INVALID OR UNCONSCIONABLE PROVISIONS OF THE CONTRACT ARE DECLARED BE SEVERABLE.

EQUIPMENT INFORMATION (REQUIRED)

Job Name: Click or tap here to

Sales Order Number: Click or tap here to enter text.

Unit Tag: Click or tap here to enter text

Date of Shipment: Click or tap here to enter text.

Serial Number: Click or tap here to enter text.

Unit Model Number: Click or tap here to enter text.

Screens

Manufacturer's Screen

R-K Electronics

DPM v0.0.00

Average Voltage Screen

VAvg	Imb	Hz	
460	0	60	off

Default – the default screen shows the real time voltage detected in each of the 3 phases:

A-B	B-C	C-A	
460	459	461	ON

Voltage Selection Screen (Vertical Format) Default = 460V, 3Ø

200, 1Ø; 208, 1Ø; 220, 1Ø; 230, 1Ø; 240, 1Ø;
200, 3Ø; 208, 3Ø; 220, 3Ø; 230, 3Ø; 240, 3Ø; 380, 3Ø; 415, 3Ø; 440, 3Ø;
460, 3Ø; 480 3Ø; 575, 3Ø; 600, 3Ø;

Over/Under voltage Percentage Screen (Vertical Format) Default = 10%

7% 8% 9% 10% 11% 12% 13% 14% & 15%

Trip Time Delay Screen (Vertical Format) Default = 5 sec

2S, 3S, 4S, 5S, 6S, 27S, 8S, 9S & 10S

Re-Start Time Delay Screen (Vertical Format) Default = 2 sec

Manual, 2S, 3S, 4S, 5S, 6S, 7S, 8S, 9S, 10S, 30S, 1M, 2M, 3M & 4M

Phase Imbalance Percentage Screen (Vertical Format) Default = 5%

3% 4% 5% 6% 7% 8% 9% & 10%

Fault Screen (Vertical Format)

“0” most recent faults, “1” previous fault “2” third oldest fault & “3” fourth oldest fault.

Fault Words:

“Phase a Loss”	(There is no voltage sensed on 3-L1/S)
“Voltage Low”	(Average line voltage is less than selected Undervoltage Percentage)
“Voltage High”	(Average line voltage is more than selected Overvoltage Percentage)
“Imbalance”	(One phase is lower than the average voltage by more than the Imbalance percentage)
“Phase Loss	(One phase is more than 30% below the Line Voltage selection)
“Bad Rotation”	(The phase rotation sequence is reversed)
“Bad Freq”	(Line frequency out of allowable range of 45 to 65 Hz)

Filter Replacement

Monthly air filter inspection is required to maintain optimum unit efficiency. It is strongly recommended that filter media be replaced monthly. Open access panel and pull filters straight out to inspect all of the filters. Replace filters with the size indicated on each filter. Arrow on the replacement filters must point towards the blower.

**WARNING**

Electric shock hazard. Shut off all electrical power to the unit to avoid shock hazard or injury from rotating parts.

Decommissioning

Before decommissioning unit, ensure you are familiar with the unit and its operation. Only individuals qualified for handling refrigerant may remove charge from the unit. Unit must be isolated electrically before beginning any decommissioning work. Proper PPE is required.

Ensure any equipment that may be needed for handling refrigerant cylinders safely is available. Equipment and cylinders used for recovery must be in good working order and comply with appropriate standards.

Remove refrigerant from all parts of the refrigeration system. On heat pumps, refrigerant must be recovered from discharge, suction and common liquid lines. Weigh out refrigerant when removing to ensure that all refrigerant is removed and cylinders are not overfilled. Place refrigerant cylinder on scales before beginning recovery process. Do not exceed maximum pressure of cylinder.

When recovery is completed, remove all cylinders containing recovered refrigerant from the site. Ensure all isolation valves on equipment are closed and all warning decals are still visible on unit.

Table 29 - M2-018

Filter Type	(Quantity) Size
	M2-018
2" Pleated - MERV 8	(8) 20" x 20"
4" Pleated - MERV 8, MERV 11, MERV 13, or MERV 14	
12" Cartridge - MERV 11, MERV 13, or MERV 14	

Table 30 - M2-026 Filters

Filter Type	(Quantity) Size
	M2-026
2" Pleated - MERV 8	(4) 16" x 20" (8) 20" x 20"
4" Pleated - MERV 8, MERV 11, MERV 13, or MERV 14	
12" Cartridge - MERV 11, MERV 13, or MERV 14	

Table 31 - M2-036 Filters

Filter Type	(Quantity) Size
	M2-036
2" Pleated - MERV 8	(6) 16" x 20" and (9) 20" x 20"
4" Pleated - MERV 8, MERV 11, MERV 13, or MERV 14	
12" Cartridge - MERV 11, MERV 13, or MERV 14	

Filter Conversion

Inches	Centimeters
[16 x 20 x 2]	[40.6 x 50.8 x 5.1]
[16 x 20 x 4]	[40.6 x 50.8 x 10.2]
[16 x 20 x 12]	[40.6 x 50.8 x 30.5]
[20 x 20 x 2]	[50.8 x 50.8 x 5.1]
[20 x 20 x 4]	[50.8 x 50.8 x 10.2]
[20 x 20 x 12]	[50.8 x 50.8 x 30.5]

20 x 20	20 x 20	20 x 20	20 x 20
20 x 20	20 x 20	20 x 20	20 x 20

M2-018

16 x 20	16 x 20	16 x 20	16 x 20
20 x 20	20 x 20	20 x 20	20 x 20
20 x 20	20 x 20	20 x 20	20 x 20

M2-026

20 x 20	20 x 20	20 x 20	20 x 16	20 x 16
20 x 20	20 x 20	20 x 20	20 x 16	20 x 16
20 x 20	20 x 20	20 x 20	20 x 16	20 x 16

M2-032 / M2-036

Figure 53 - Filter Layout
(Viewed from the Upstream Side of the Cooling Coil)

Appendix A - Heat Exchanger Corrosion Resistance

Corrosion Resistance of Copper and Stainless Steel in Brazed Plate Heat Exchangers - Points to Measure and Check in a Water Analysis

The resistance guide provides the corrosion resistance of stainless steel type AISI 316 and pure Copper (99.9%) in water, to a number of important chemical factors. The actual corrosion is a very complex process influenced by many different factors in combination.

Explanations: + Good resistance under normal conditions

0 Corrosion problems may occur especially when more factors are valued 0

- Use is not recommended

Water Containing	Concentration (mg/l or ppm)	Time Limits - Analyze Before	AISI 316	SMO 254	Copper Alloy	Nickel Alloy
Alkalinity (HCO ₃ ⁻)	< 70	Within 24 Hours	+	+	0	+
	70-300		+	+	+	+
	> 300		+	+	0/+	+
Sulfate (SO ₄ ²⁻)	< 70	No Limit	+	+	+	+
	70-300		+	+	0/-	+
	> 300		0	0	-	+
HCO ₃ ⁻ / SO ₄ ²⁻	> 1.0	No Limit	+	+	+	+
	< 1.0		+	+	0/-	+
Electrical Conductivity	< 10µS/cm	No Limit	+	+	0	+
	10-500 µS/cm		+	+	+	+
	> 500 µS/cm		+	+	0	+
pH	< 6.0	Within 24 Hours	0	0	0	+
	6.0-7.5		0/+	+	0	+
	7.5-9.0		+	+	+	+
	> 9.0		+	+	0	+
Ammonium (NH ₄ ⁺)	< 2	Within 24 Hours	+	+	+	+
	2-20		+	+	0	+
	> 20		+	+	-	+
Chlorides (Cl ⁻)*	< 300	No Limit	+	+	+	+
	> 300		0	+	0/+	+
Free Chlorine (Cl ₂)	< 1	Within 5 Hours	+	+	+	+
	1-5		+	+	0	+
	> 5		0/+	+	0/-	+
Hydrogen Sulfide (H ₂ S)	< 0.05	No Limit	+	+	+	+
	> 0.05		+	+	0/-	+
Free (aggressive) Carbon Dioxide (CO ₂)	< 5	No Limit	+	+	+	+
	5-20		+	+	0	+
	> 20		+	+	-	+

*See Chloride Content Table

Water Containing	Concentration (mg/l or ppm)	Time Limits - Analyze Before	AISI 316	SMO 254	Copper Alloy	Nickel Alloy
Total Hardness (°dH)	4.0-8.5	No Limit	+	+	+	+
Nitrate (NO ₃)	< 100	No Limit	+	+	+	+
	> 100		+	+	0	+
Iron (Fe)	< 0.2	No Limit	+	+	+	+
	> 0.2		+	+	0	+
Aluminum (Al)	< 0.2	No Limit	+	+	+	+
	> 0.2		+	+	0	+
Manganese (Mn)	< 0.1	No Limit	+	+	+	+
	> 0.1		+	+	0	+

Chloride Content

Chloride Content	Maximum Temperature			
	60°C (140°F)	80°C (176°F)	120°C (248°F)	130°C (266°F)
= 10 ppm	SS 304	SS 304	SS 304	SS 316
= 25 ppm	SS 304	SS 304	SS 316	SS 316
= 50 ppm	SS 304	SS 316	SS 316	Ti / SMO 254
= 80 ppm	SS 316	SS 316	SS 316	Ti / SMO 254
= 150 ppm	SS 316	SS 316	Ti / SMO 254	Ti / SMO 254
= 300 ppm	SS 316	Ti / SMO 254	Ti / SMO 254	Ti / SMO 254
> 300 ppm	Ti / SMO 254	Ti / SMO 254	Ti / SMO 254	Ti / SMO 254

Split System Piping Diagrams

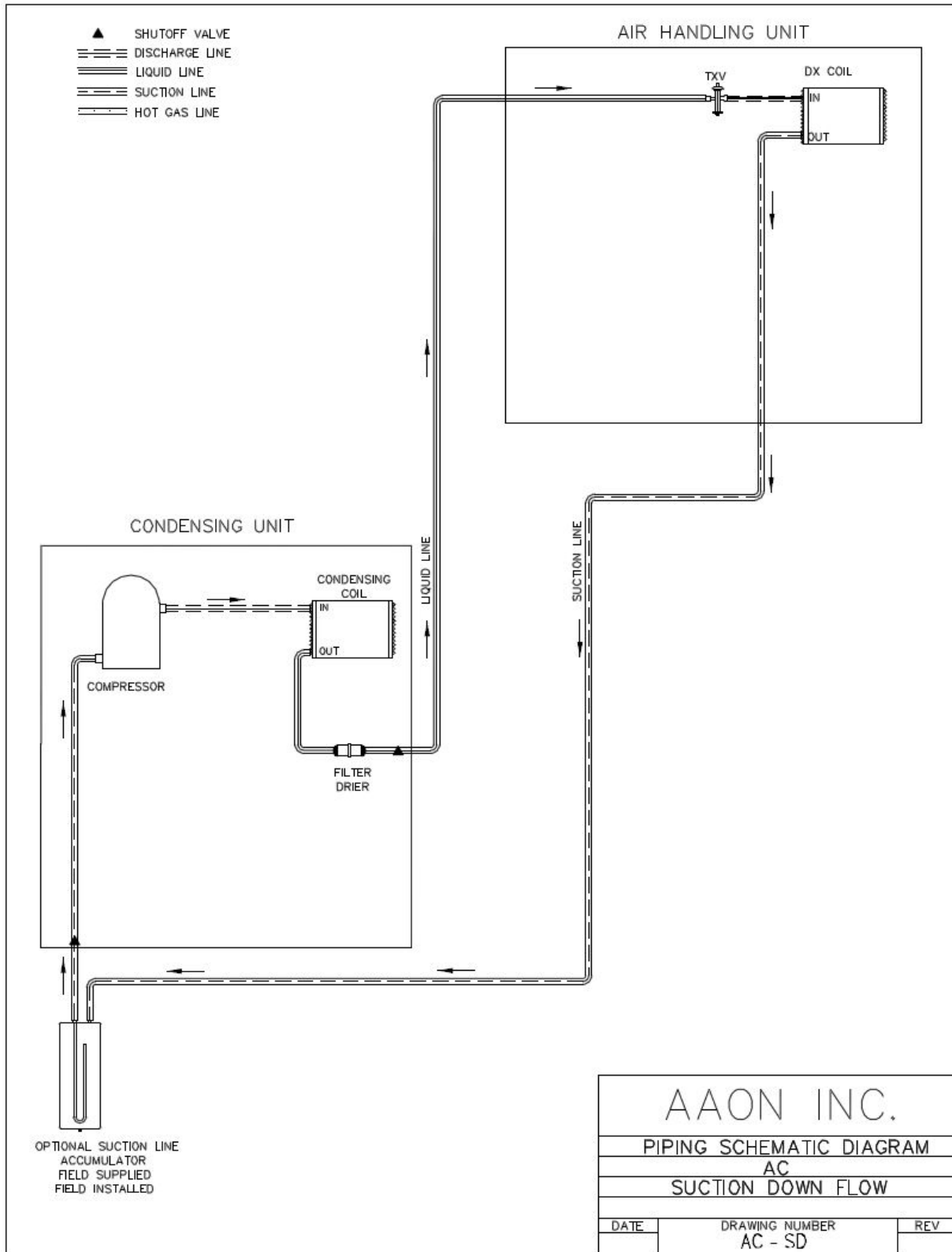

Figure 54 - A/C Split System Piping, Suction Down

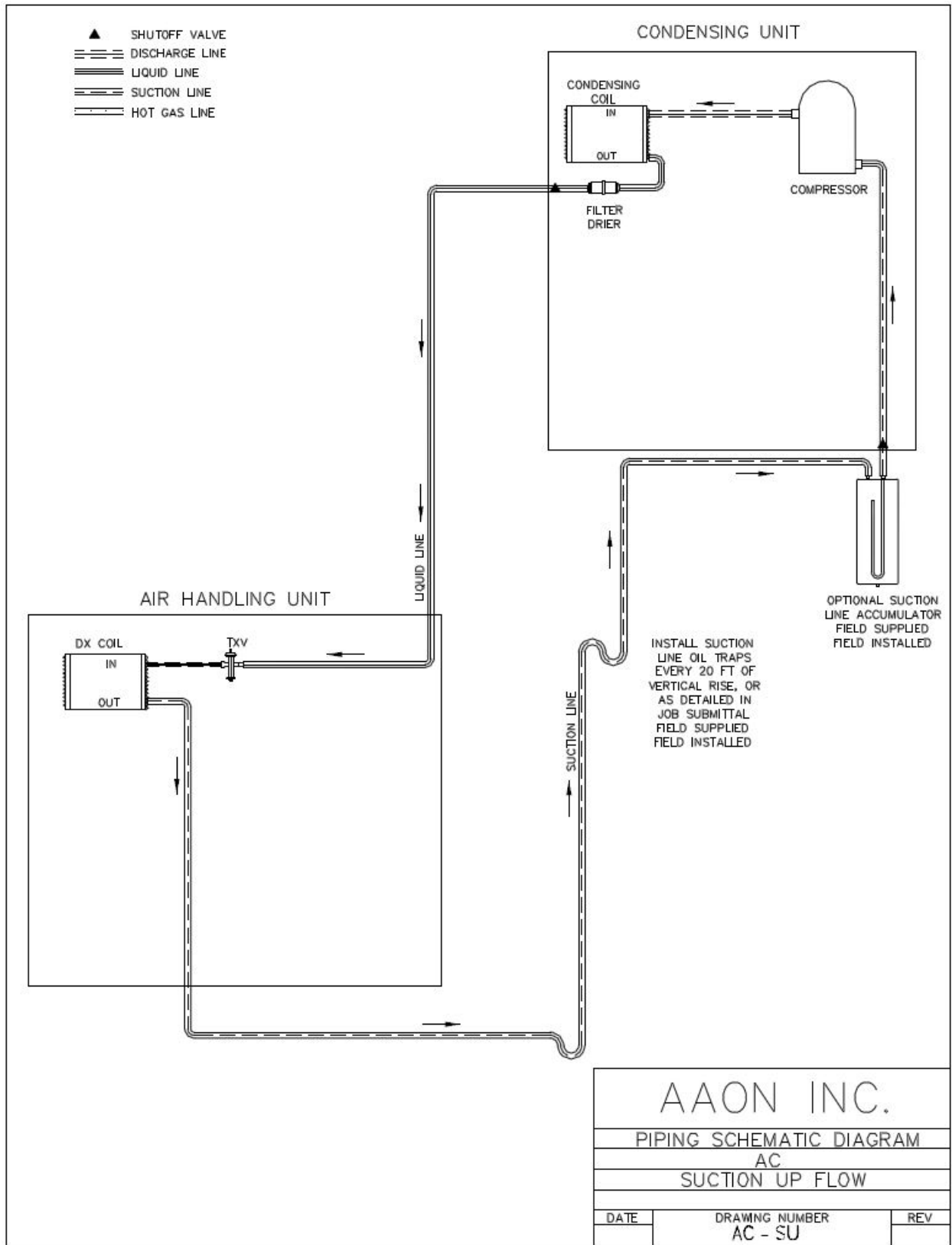

Figure 55 - A/C Split System Piping, Suction Up

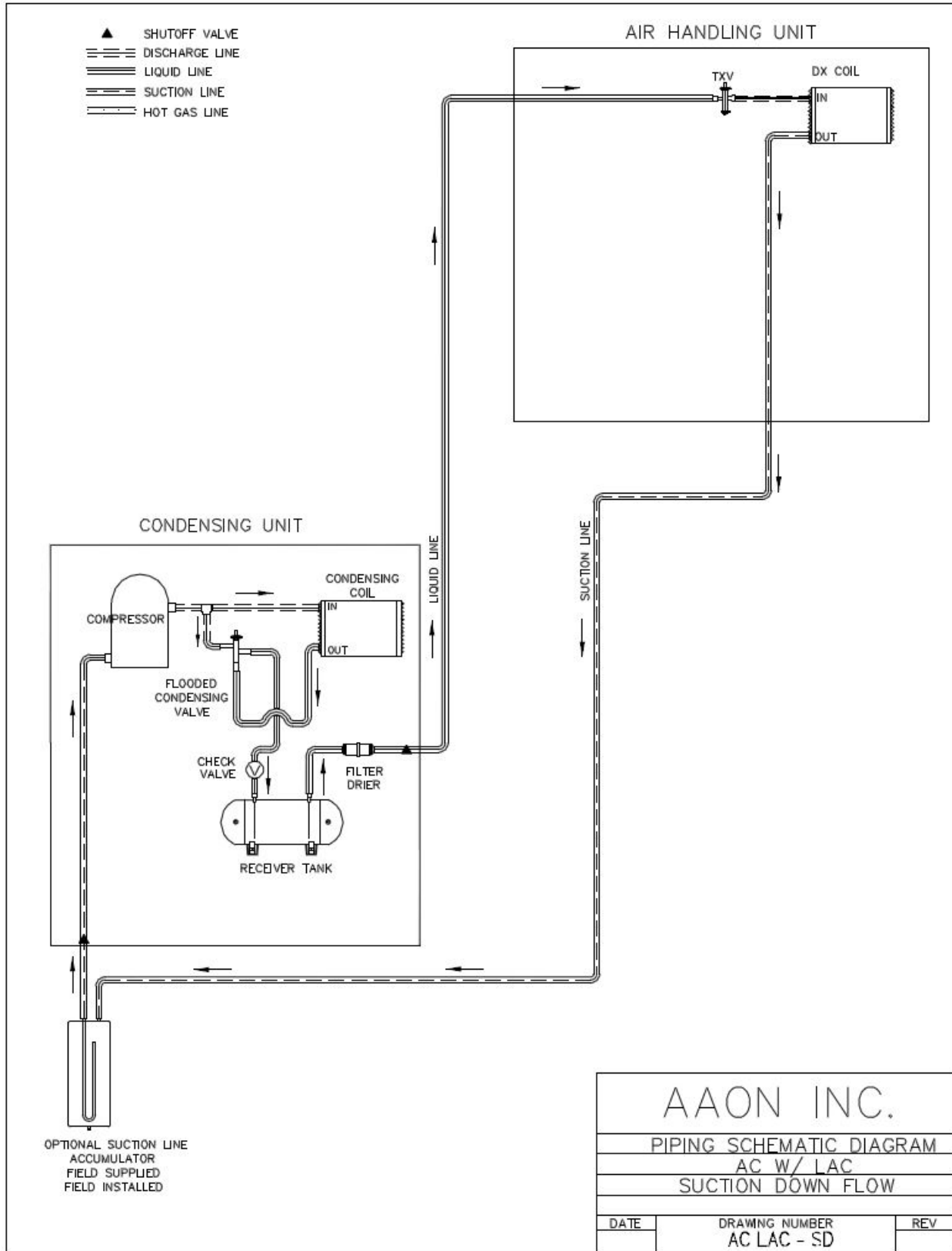

Figure 56 - A/C with LAC Split System Piping, Suction Down

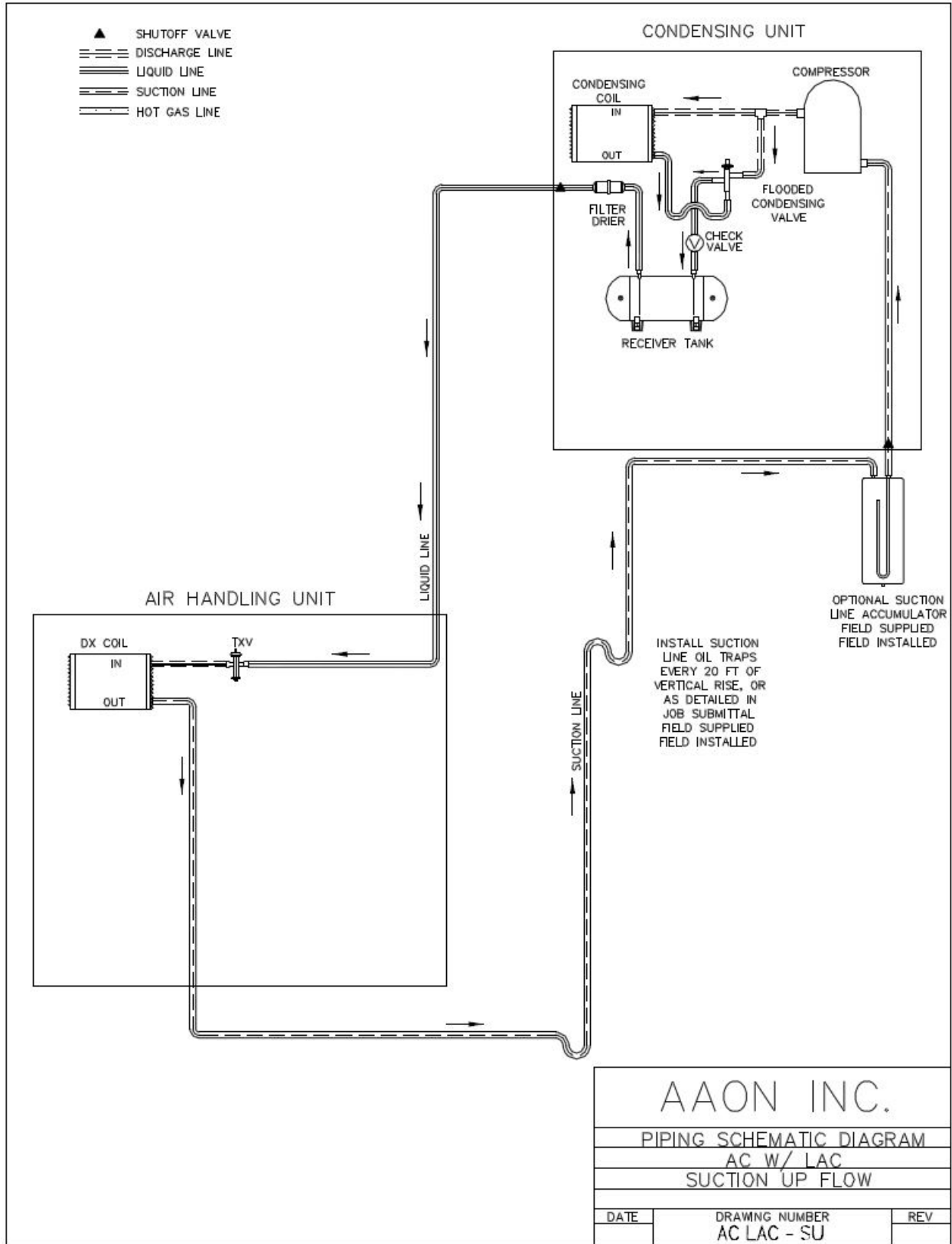

Figure 57 - A/C with LAC Split System Piping, Suction Up

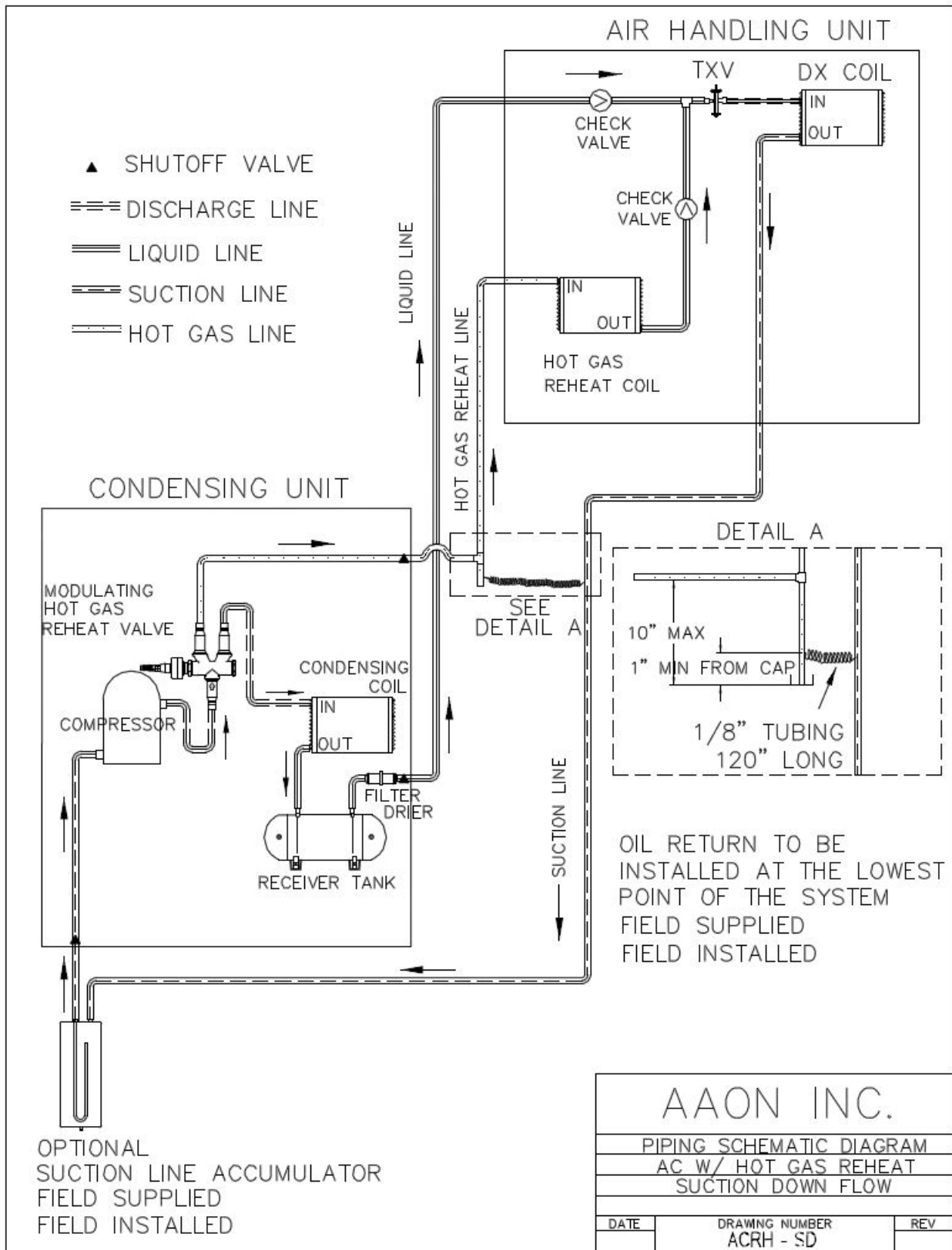

Figure 58 - A/C with Modulating Hot Gas Reheat Split System Piping, Suction Down

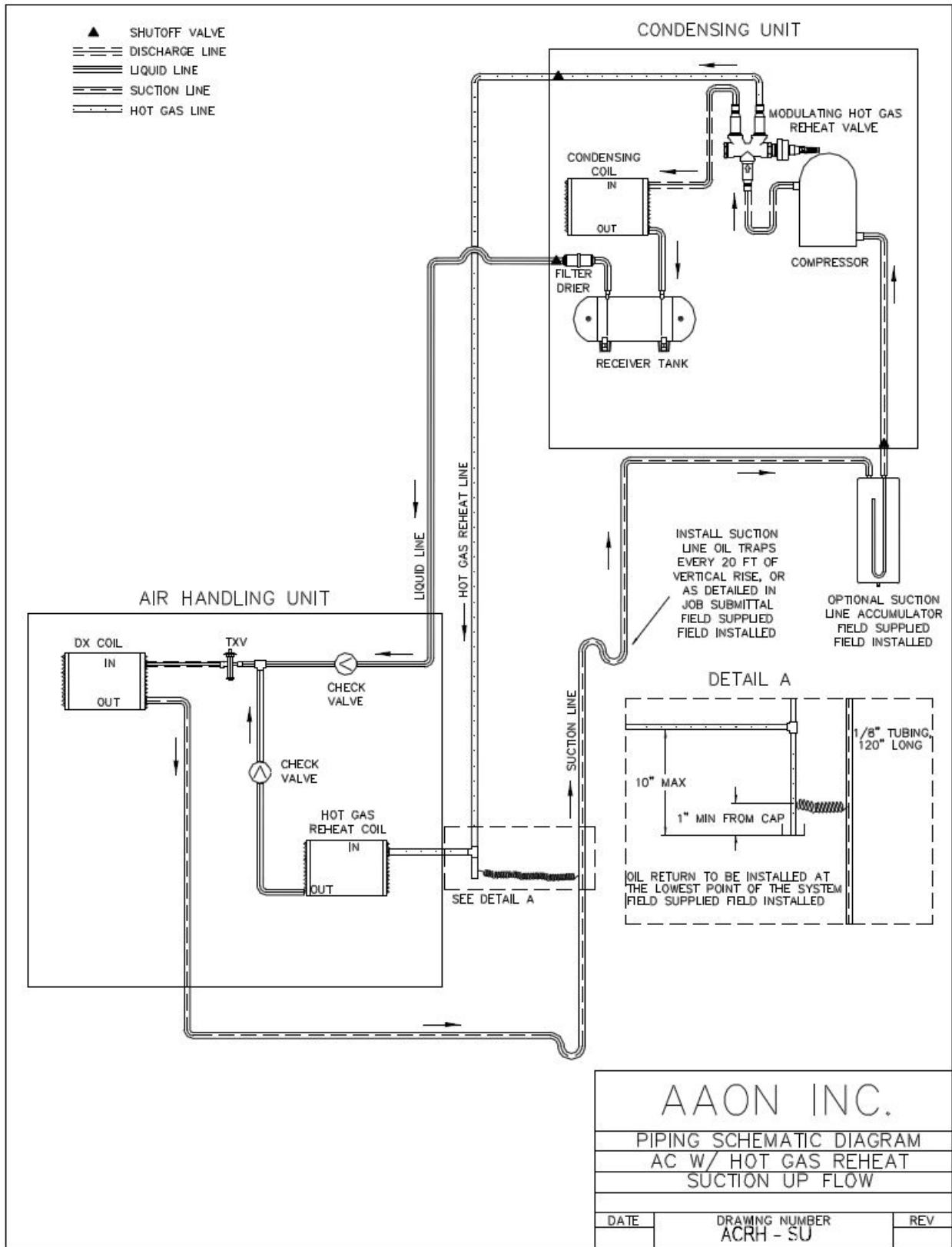

Figure 59 - A/C with Modulating Hot Gas Reheat Split System Piping, Suction Up

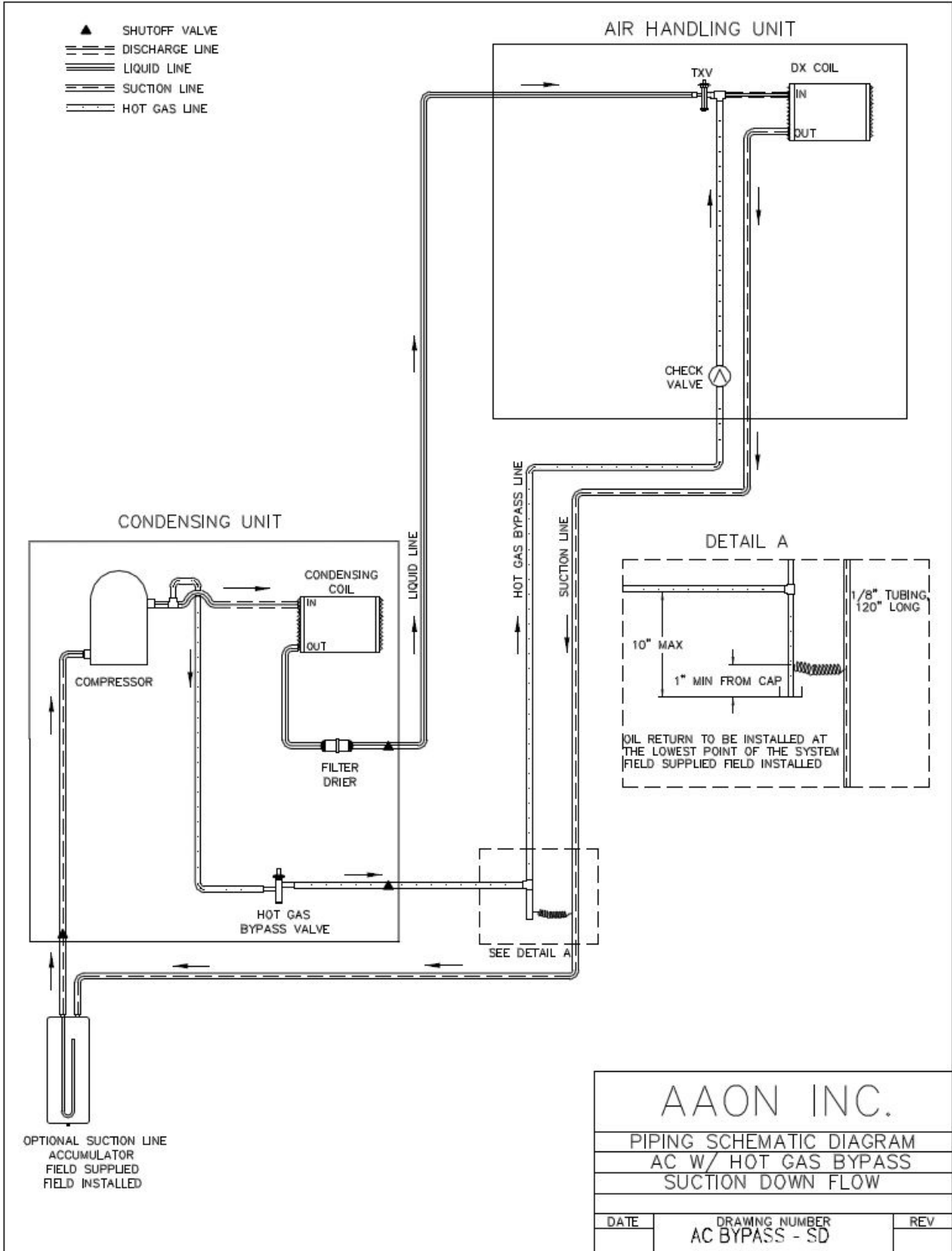

Figure 60 - A/C with Hot Gas Bypass Split System Piping, Suction Down

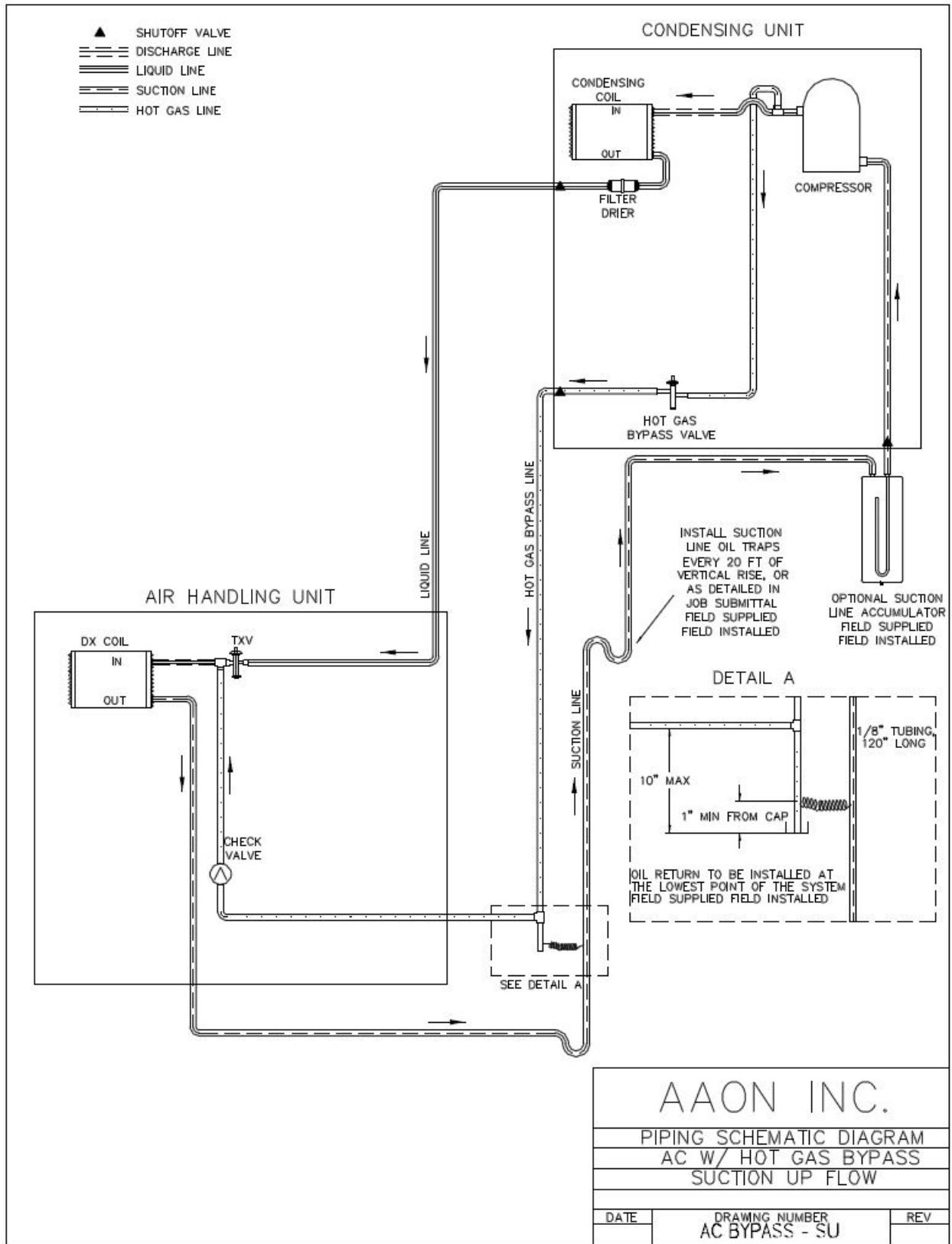

Figure 61 - A/C with Hot Gas Bypass Split System Piping, Suction Up

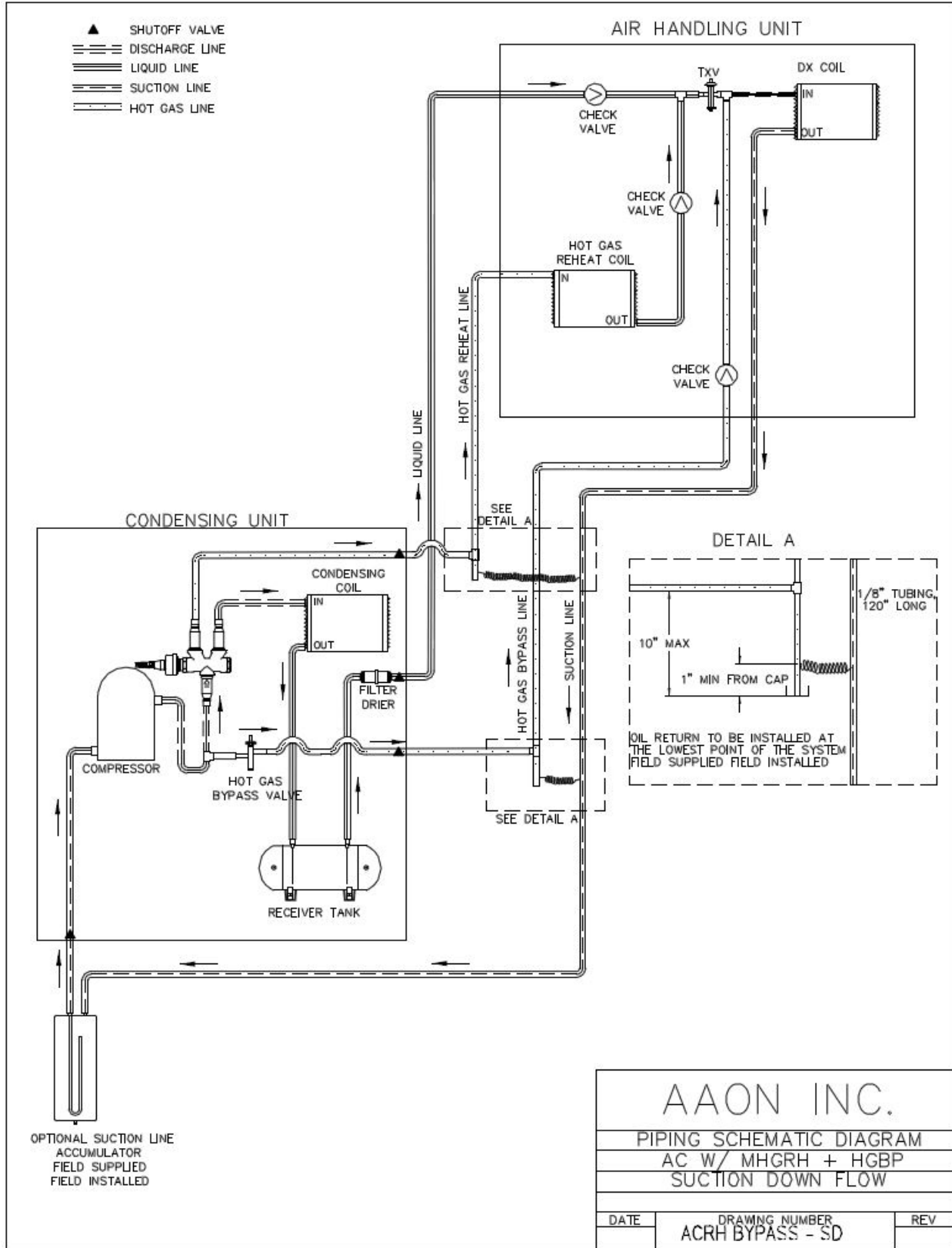

Figure 62 - A/C with Modulating Hot Gas Reheat and Hot Gas Bypass Split System Piping, Suction Down

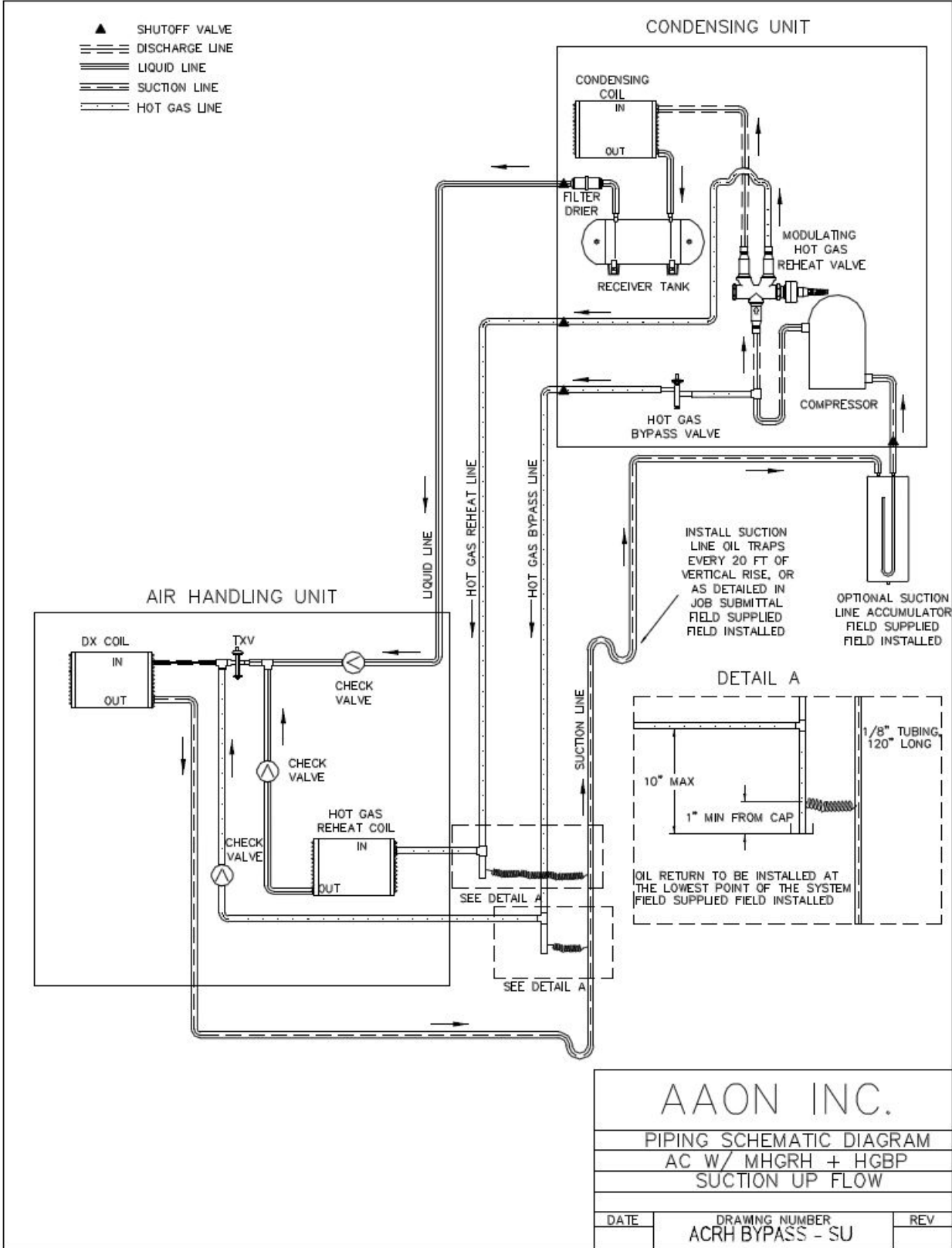

Figure 63 - A/C with Modulating Hot Gas Reheat and Hot Gas Bypass Split System Piping, Suction Up

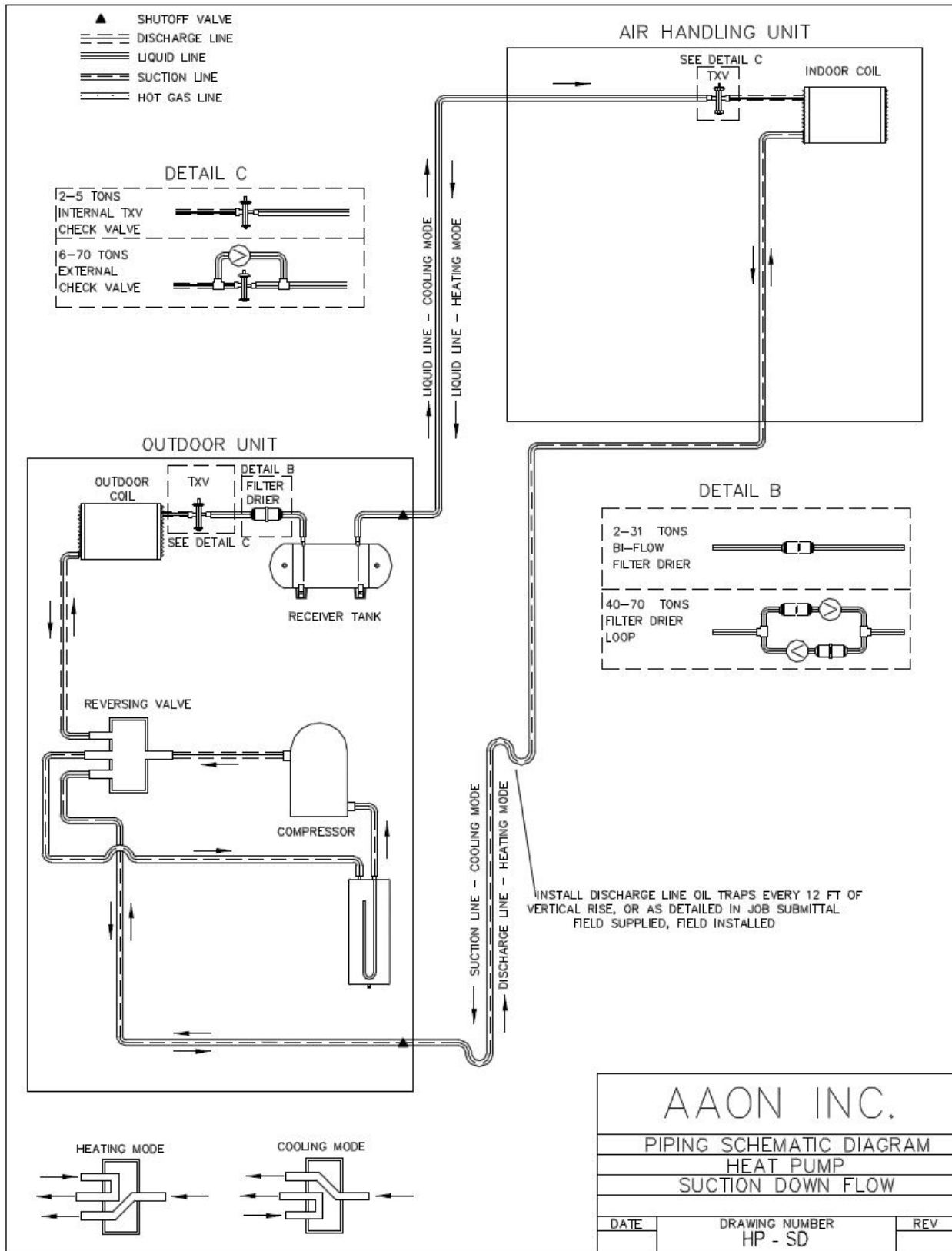

Figure 64 - Heat Pump Split System Piping, Suction Down

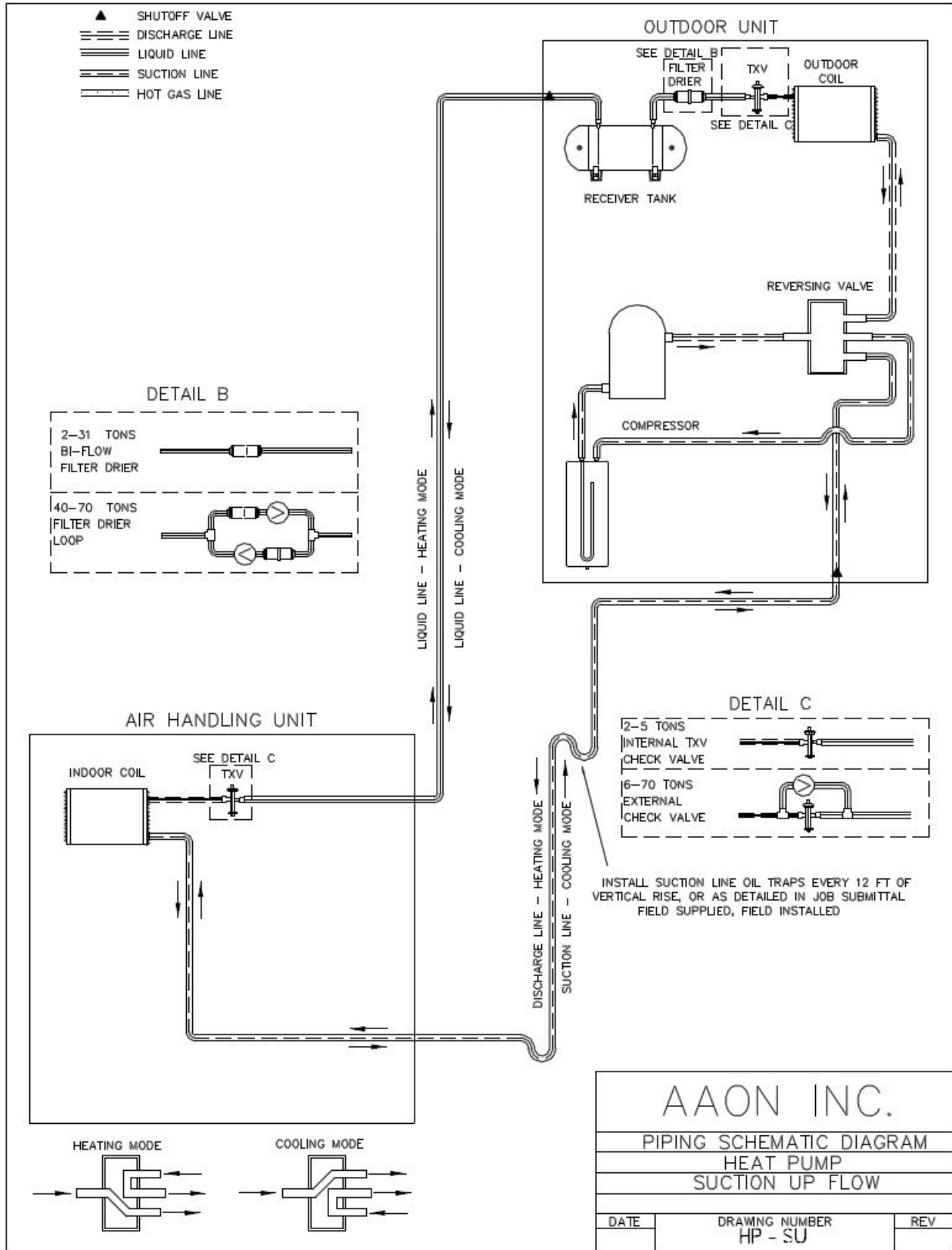

Figure 65 - Heat Pump Split System Piping, Suction Up

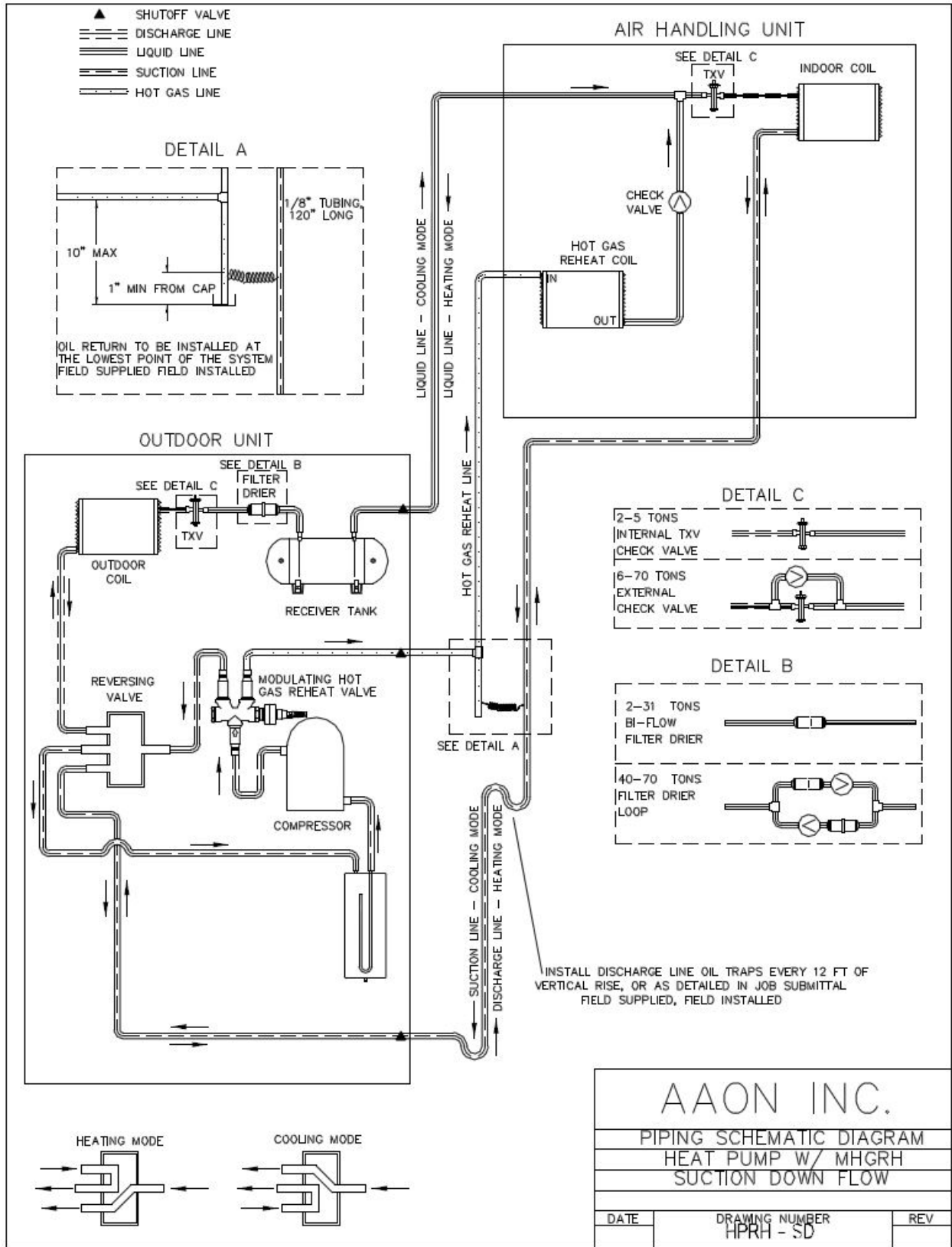

Figure 66 - Heat Pump with Modulating Hot Gas Reheat Split System Piping, Suction Down

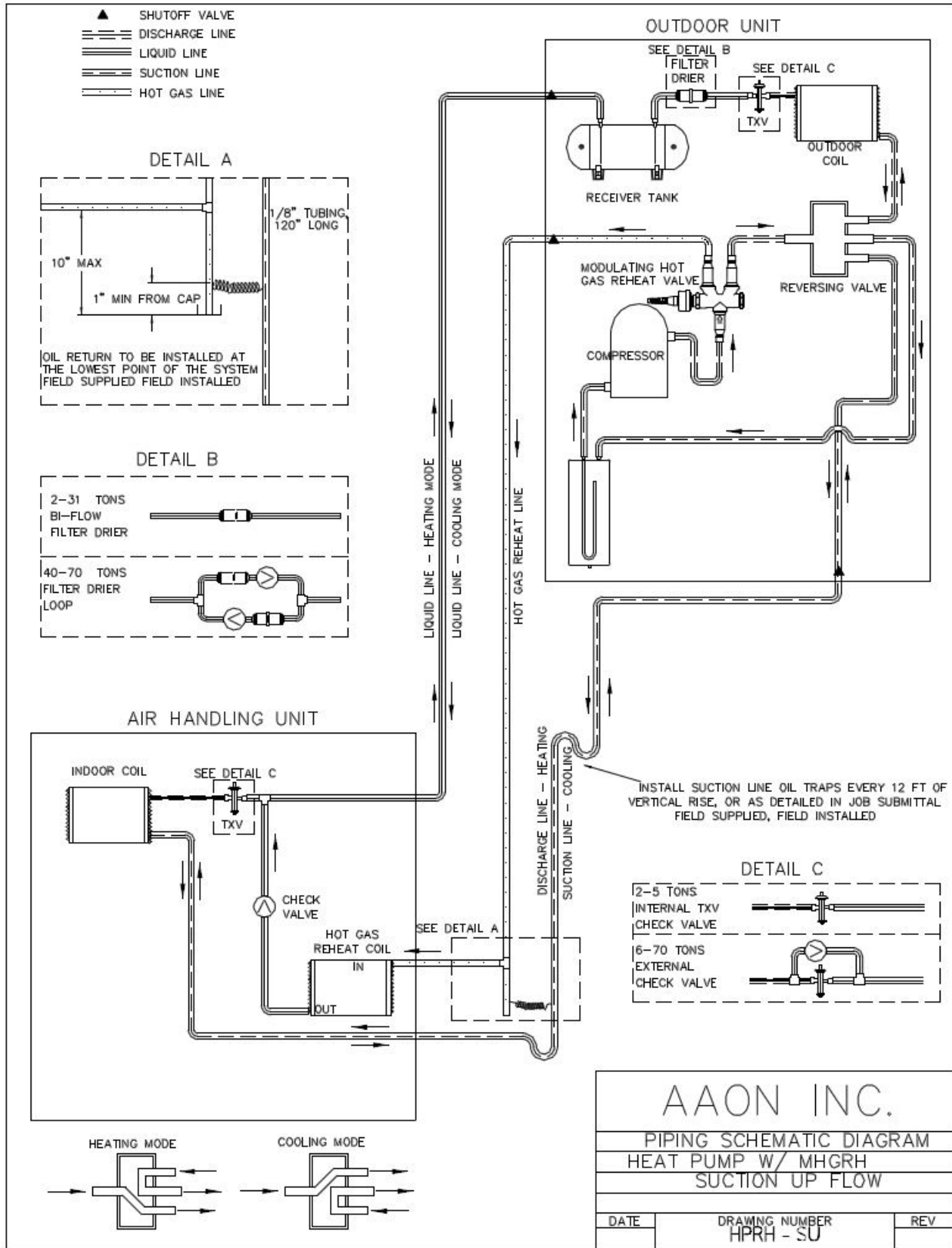

Figure 67 - Heat Pump with Modulating Hot Gas Reheat Split System Piping, Suction Up

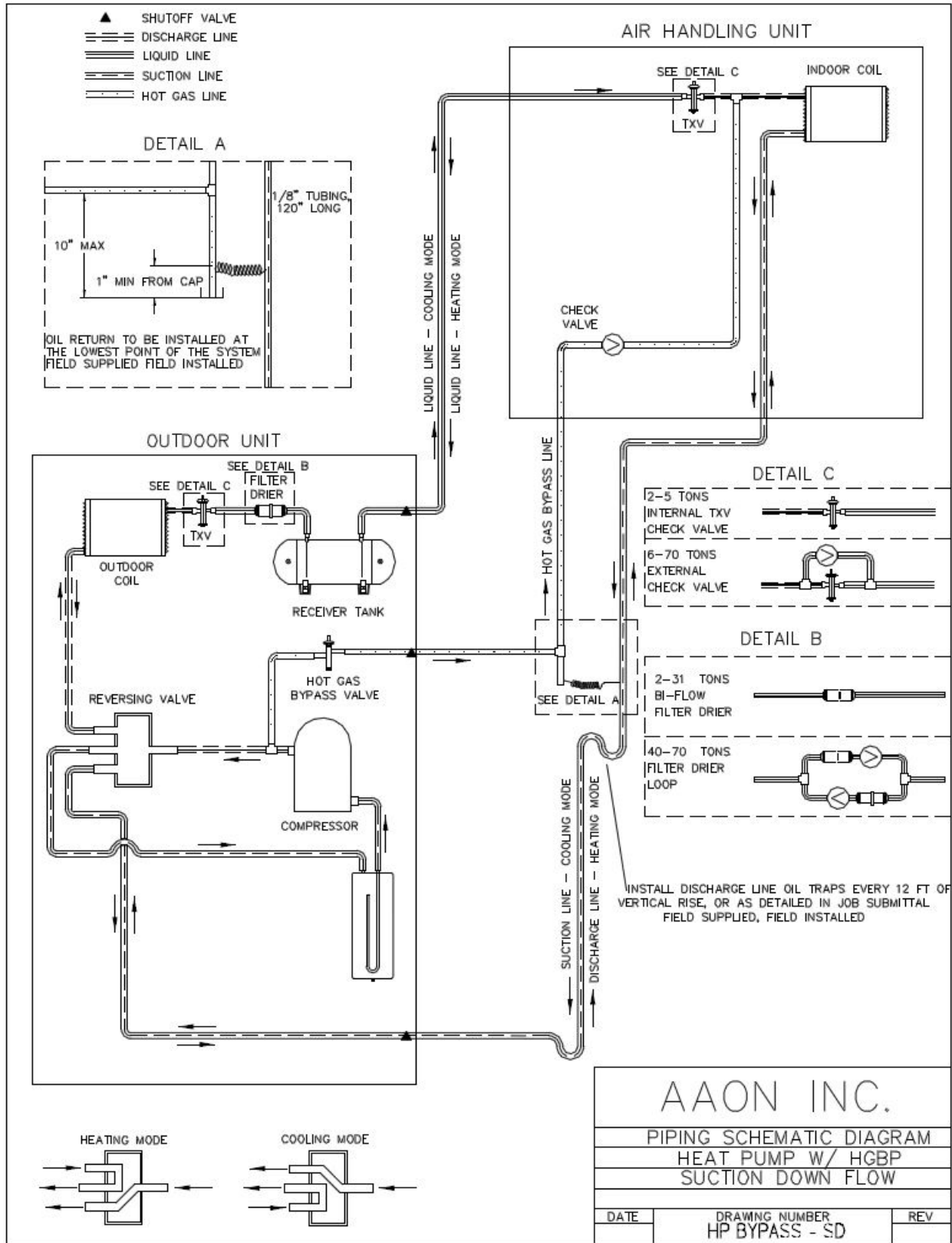

Figure 68 - Heat Pump with Hot Gas Bypass Split System Piping, Suction Down

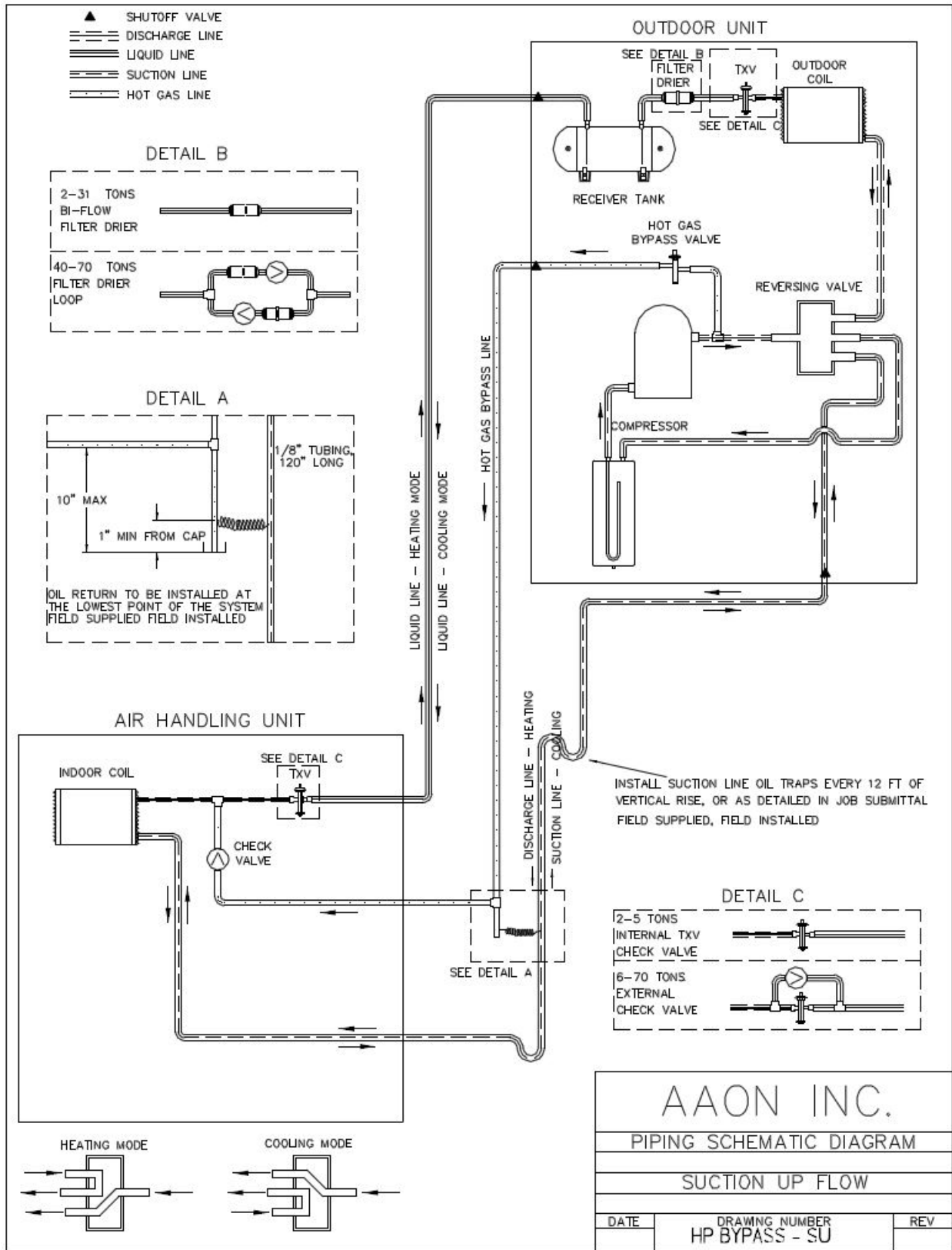

Figure 69 - Heat Pump with Hot Gas Bypass Split System Piping, Suction Up

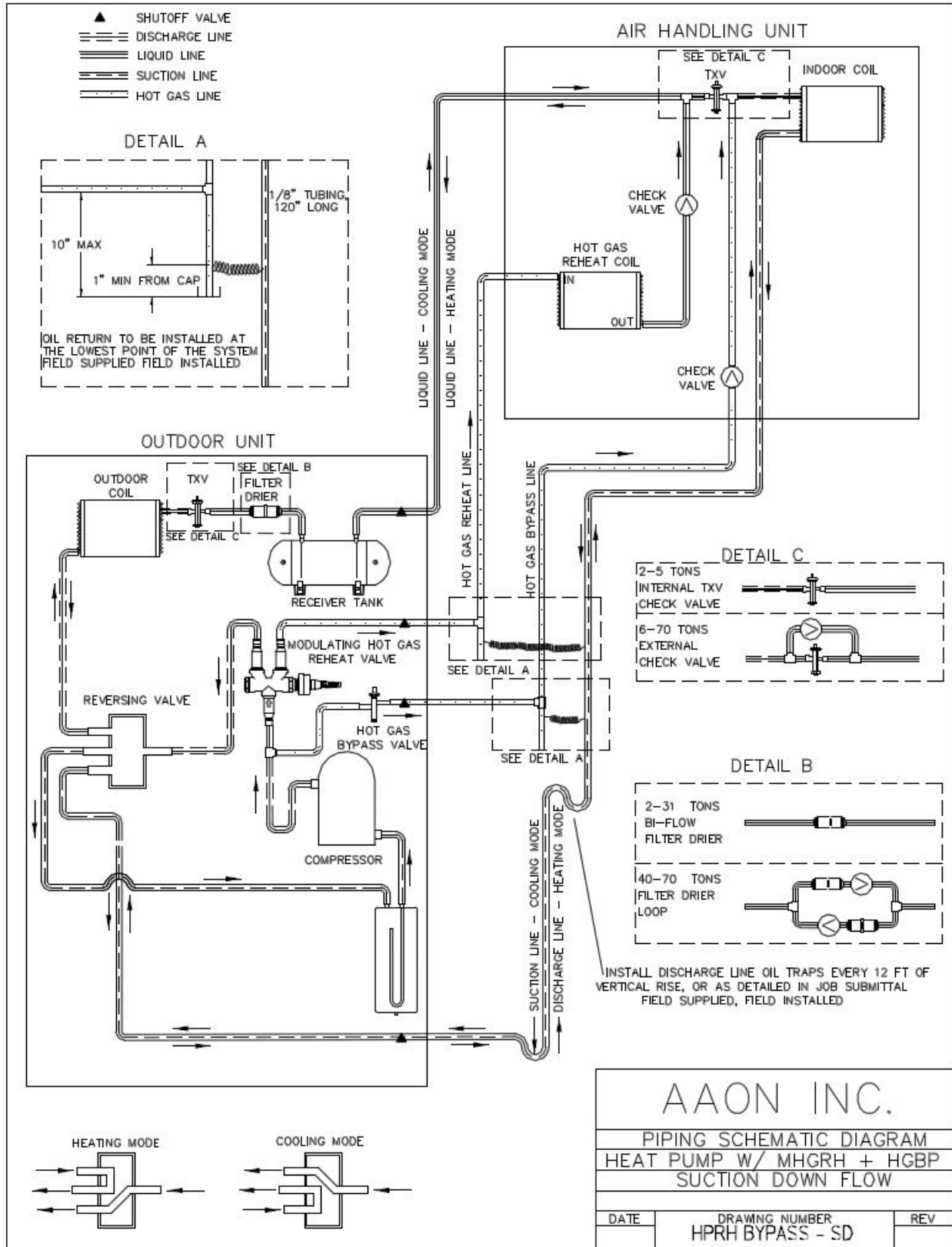

Figure 70 - Heat Pump with Modulating Hot Gas Reheat and Hot Gas Bypass Split System Piping, Suction Down

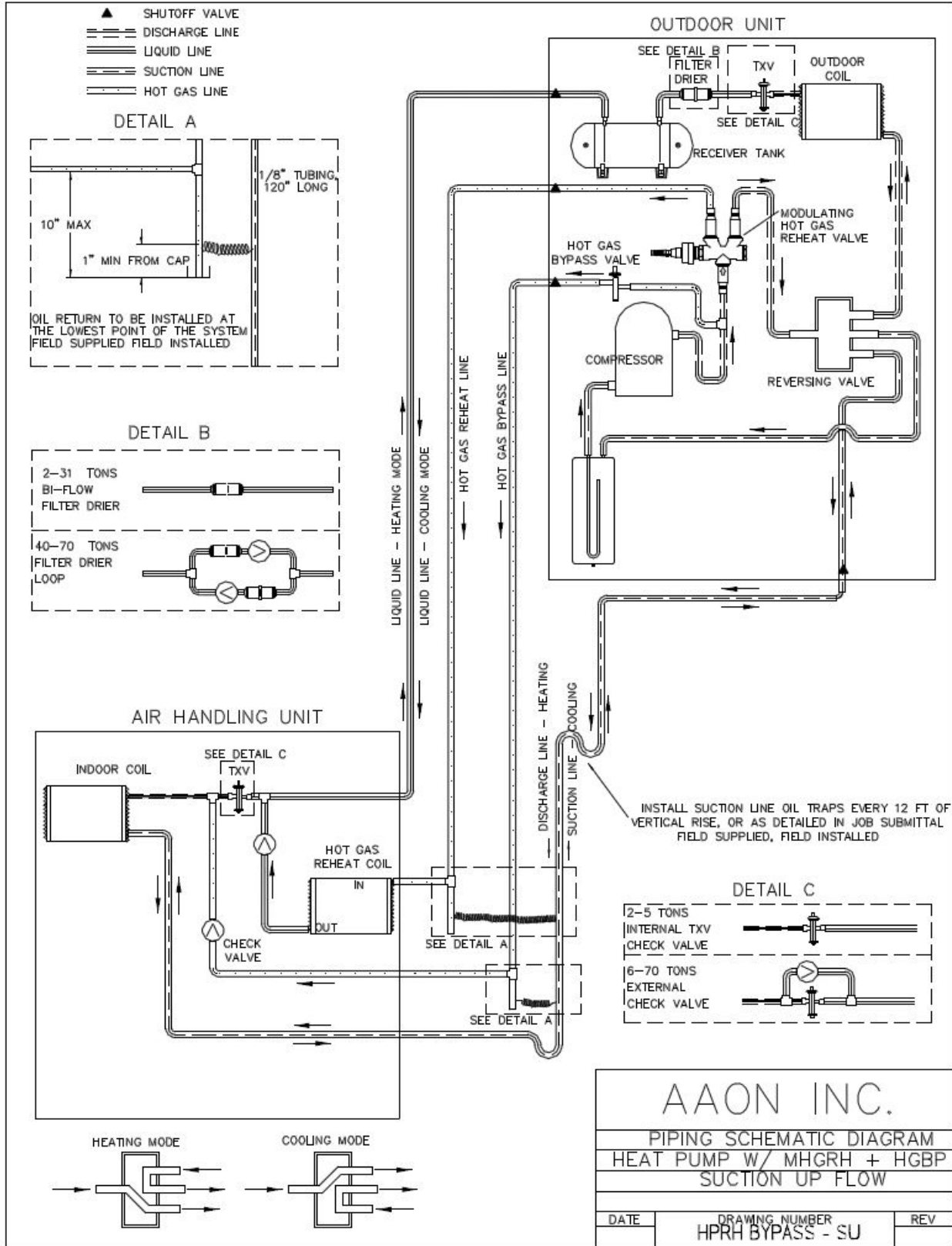

Figure 71 - Heat Pump with Modulating Hot Gas Reheat and Hot Gas Bypass Split System Piping, Suction Up

M2 Series Startup Form

Job Name: _____	Date: _____
Address: _____	
Model Number: _____	
Serial Number: _____	Tag: _____
Startup Contractor: _____	
Address: _____	
Phone: _____	

Pre Startup Checklist

Installing contractor should verify the following items.	
1. Is there any visible shipping damage?	<input type="checkbox"/> Yes <input type="checkbox"/> No
2. Is the unit level?	<input type="checkbox"/> Yes <input type="checkbox"/> No
3. Are the unit clearances adequate for service and operation?	<input type="checkbox"/> Yes <input type="checkbox"/> No
4. Do all access doors open freely and are the handles operational?	<input type="checkbox"/> Yes <input type="checkbox"/> No
5. Have all shipping braces been removed?	<input type="checkbox"/> Yes <input type="checkbox"/> No
6. Have all electrical connections been tested for tightness?	<input type="checkbox"/> Yes <input type="checkbox"/> No
7. Does the electrical service correspond to the unit nameplate?	<input type="checkbox"/> Yes <input type="checkbox"/> No
8. On 208/230V units, has transformer tap been checked?	<input type="checkbox"/> Yes <input type="checkbox"/> No
9. Has overcurrent protection been installed to match the unit nameplate requirement?	<input type="checkbox"/> Yes <input type="checkbox"/> No
10. Have all set screws on the fans been tightened?	<input type="checkbox"/> Yes <input type="checkbox"/> No
11. Do all fans rotate freely?	<input type="checkbox"/> Yes <input type="checkbox"/> No
12. Does the field water piping to the unit appear to be correct per design parameters?	<input type="checkbox"/> Yes <input type="checkbox"/> No
13. Is all copper tubing isolated so that it does not rub?	<input type="checkbox"/> Yes <input type="checkbox"/> No
14. Have the damper assemblies been inspected?	<input type="checkbox"/> Yes <input type="checkbox"/> No
15. Are air filters installed with proper orientation?	<input type="checkbox"/> Yes <input type="checkbox"/> No
16. Have condensate drain and p-trap been connected?	<input type="checkbox"/> Yes <input type="checkbox"/> No
17. Is the TXV sensing bulb in the correct location?	<input type="checkbox"/> Yes <input type="checkbox"/> No
18. Does the TXV sensing bulb have proper thermal contact and is properly insulated?	<input type="checkbox"/> Yes <input type="checkbox"/> No

Ambient Temperature

Ambient Dry Bulb Temperature _____ °C/°F	Ambient Wet Bulb Temperature _____ °C/°F
---	---

Supply Fan Assembly

Alignment <input type="checkbox"/>		Check Rotation <input type="checkbox"/>		Nameplate Amps _____
Number	hp	L1	L2	L3
1				
2				
Band Size _____		VAV Controls _____		
VFD Frequency _____		Springs Operating Correctly <input type="checkbox"/>		

Energy Recovery Wheel Assembly

Wheels Spin Freely <input type="checkbox"/>		Check Rotation <input type="checkbox"/>		FLA _____
Number	hp	L1	L2	L3
1				
2				

Power Exhaust Fan Assembly

Alignment <input type="checkbox"/>		Check Rotation <input type="checkbox"/>		Nameplate Amps _____
Number	hp	L1	L2	L3
1				
2				
Band Size _____		Springs Operating Correctly <input type="checkbox"/>		
VFD Frequency _____		Springs Operating Correctly <input type="checkbox"/>		

Power Return Fan Assembly

Alignment <input type="checkbox"/>		Check Rotation <input type="checkbox"/>		Nameplate Amps _____
Number	hp	L1	L2	L3
1				
2				
Band Size _____		Springs Operating Correctly <input type="checkbox"/>		
VFD Frequency _____		Springs Operating Correctly <input type="checkbox"/>		

Outside Air/Economizer Dampers

OA Operation Check <input type="checkbox"/>	Damper Wiring Check <input type="checkbox"/>	Gears Check <input type="checkbox"/>
RA Operation Check <input type="checkbox"/>	Damper Wiring Check <input type="checkbox"/>	Gears Check <input type="checkbox"/>
EA Operation Check <input type="checkbox"/>	Damper Wiring Check <input type="checkbox"/>	Gears Check <input type="checkbox"/>
Damper Actuator Type: _____		
Economizer Changeover Type and Operation: _____		

Unit Configuration

Water-Cooled Condenser <input type="checkbox"/>	Air-Cooled Condenser <input type="checkbox"/>
No Water Leaks <input type="checkbox"/>	Condenser Safety Check <input type="checkbox"/>
Water Flow _____ gpm	
Water Inlet Temperature _____ °C/°F	Water Outlet Temperature _____ °C/°F

Compressors/DX Cooling

Check Rotation <input type="checkbox"/>						
Number	L1	L2	L3	Head Pressure KPA/PSIG	Suction Pressure KPA/PSIG	Crankcase Heater Amps
1						
2						
3						
4						

Refrigeration System 1 - Cooling Mode

	Pressure	Saturated Temperature	Line Temperature	Sub-cooling	Superheat
Discharge				N/A	N/A
Suction				N/A	
Liquid					N/A

Refrigeration System 2 - Cooling Mode

	Pressure	Saturated Temperature	Line Temperature	Sub-cooling	Superheat
Discharge				N/A	N/A
Suction				N/A	
Liquid					N/A

Refrigeration System 3 - Cooling Mode

	Pressure	Saturated Temperature	Line Temperature	Sub-cooling	Superheat
Discharge				N/A	N/A
Suction				N/A	
Liquid					N/A

Refrigeration System 4 - Cooling Mode

	Pressure	Saturated Temperature	Line Temperature	Sub-cooling	Superheat
Discharge				N/A	N/A
Suction				N/A	
Liquid					N/A

Refrigeration System 1 - Heating Mode (Heat Pump Only)

	Pressure	Saturated Temperature	Line Temperature	Sub-cooling	Superheat
Discharge				N/A	N/A
Suction				N/A	
Liquid					N/A

Refrigeration System 2 - Heating Mode (Heat Pump Only)

	Pressure	Saturated Temperature	Line Temperature	Sub-cooling	Superheat
Discharge				N/A	N/A
Suction				N/A	
Liquid					N/A

Refrigeration System 3 - Heating Mode (Heat Pump Only)

	Pressure	Saturated Temperature	Line Temperature	Sub-cooling	Superheat
Discharge				N/A	N/A
Suction				N/A	
Liquid					N/A

Refrigeration System 4 - Heating Mode (Heat Pump Only)

	Pressure	Saturated Temperature	Line Temperature	Sub-cooling	Superheat
Discharge				N/A	N/A
Suction				N/A	
Liquid					N/A

Air-Cooled Condenser

Alignment <input type="checkbox"/>		Check Rotation <input type="checkbox"/>		Nameplate Amps _____
Number	hp	L1	L2	L3
1				
2				
3				
4				
5				
6				

Water/Glycol System

1. Has the entire system been flushed and pressure checked?	<input type="checkbox"/> Yes <input type="checkbox"/> No
2. Has the entire system been filled with fluid?	<input type="checkbox"/> Yes <input type="checkbox"/> No
3. Has air been bled from the heat exchangers and piping?	<input type="checkbox"/> Yes <input type="checkbox"/> No
4. Is the glycol the proper type and concentration (N/A if water)?	<input type="checkbox"/> Yes <input type="checkbox"/> No
5. Is there a minimum load of 50% of the design load?	<input type="checkbox"/> Yes <input type="checkbox"/> No
6. Has the water piping been insulated?	<input type="checkbox"/> Yes <input type="checkbox"/> No
7. What is the freeze point of the glycol (N/A if water)? _____	

Electric Heating

Stages _____		Limit Lockout <input type="checkbox"/>		Aux. Limit Lockout <input type="checkbox"/>	
Stage	Amps	Stage	Amps	Stage	Amps
1		5			
2		6			
3		7			
4		8			

Electric Preheating

Limit Lockout <input type="checkbox"/>		Aux. Limit Lockout <input type="checkbox"/>	
Outside Air Temperature Setpoint _____ °C/°F			
Preheat Leaving Air Temperature Setpoint _____ °C/°F			
Stage	Amps	Stage	Amps
1		3	
2		4	

Gas Heating

1. Have all gas lines & connections been checked for leaks?	<input type="checkbox"/> Yes <input type="checkbox"/> No
2. Is there adequate combustion air?	<input type="checkbox"/> Yes <input type="checkbox"/> No
3. Have condensate drain lines been installed if needed?	<input type="checkbox"/> Yes <input type="checkbox"/> No
4. Has air been purged from the lines?	<input type="checkbox"/> Yes <input type="checkbox"/> No
5. Has pilot spark been verified?	<input type="checkbox"/> Yes <input type="checkbox"/> No

Staged Gas Heat

Type of Gas	Natural Gas <input type="checkbox"/>	Propane <input type="checkbox"/>	
Stage	Manifold Pressure (mmHg/"w.c.)	Stage	Manifold Pressure (mmHg/"w.c.)
1		3	
2		4	

Modulating Gas Heat

Type of Gas		Natural Gas (5:1) <input type="checkbox"/>	Propane (3:1) <input type="checkbox"/>
Analog Input	VDC	Low Fire @ 0 VDC	High Fire @ 10 VDC
Gas Pressure @ Train Inlet	mmHg/"w.c.		
Gas Pressure @ Burner Manifold	mmHg/"w.c.		
CO2 in Flue Gas %	%		
CO2 in Flue Gas ppm	ppm		
Flue Gas Temp @ Discharge	°C/°F		
Temperature Rise	°C/°F		

Maintenance Log

This log must be kept with the unit. It is the responsibility of the owner and/or maintenance/service contractor to document any service, repair or adjustments. AAON Service and Warranty Departments are available to advise and provide phone help for proper operation and replacement parts. The responsibility for proper startup, maintenance and servicing of the equipment falls to the owner and qualified licensed technician.

Entry Date	Action Taken	Name/Tel.

Literature Change History

March 2020

Updated bolted base rail figure to show the metal bolt casing installed and updated instructions to make it more clear how to install it. Updated ECM potentiometer figures.

December 2023

Start of new UL 60335 version of M2 series IOM Revision A. Added New UL 60335 tables and standard. Added 35 and 65 KAIC tables. Add Min and Max Water temps and pressures table. Added 454B Pressure Temperature charts as well as metric and imperial versions of 410A and 454B. Add new warning labels. Updated Feature string. Added metric conversions to all units in the IOM.

May 2024

Removed any information relating to 454b refrigerant since this manual pertains ONLY to 410a refrigerant and.

August 2024

Added process of Decommissioning the unit. Added text to General Information stating the maximum installation elevation is 11,500 ft.



AAON
203 Gum Springs Rd.
Longview, TX 75602-1721
www.AAON.com

M2 Series
Installation, Operation &
Maintenance
G149590 · Rev. A · 240828
(ACP J000304)

Factory Technical Support: 918-382-6450

Note: Before calling Technical Support, please have the model and serial number of the unit available.

Parts: For replacement parts, please contact your local AAON Representative.

It is the intent of AAON to provide accurate and current product information. However, in the interest of product improvement, AAON reserves the right to change pricing, specifications, and/or design of its product without notice, obligation, or liability.

Copyright © AAON, all rights reserved throughout the world.
AAON® and AAONAIRE® are registered trademarks of AAON, Inc., Tulsa, OK.